



BRUNSTAD

NORDIC WARMTH



Produktinformasjon

SYSTEM+ AMI, JULIA & MALIN

AMI, JULIA & MALIN

DESIGN: ARILD ALNES & HELGE TARALDSEN

Alle System+ modeller har en fast og formstøpt rygg, som gir god støtte. Form og søm på vange, setepute og rygg, er det som skiller modellene fra hverandre, samt sømbildet på seteputene og kantsømmene.

SOFA OG STOL

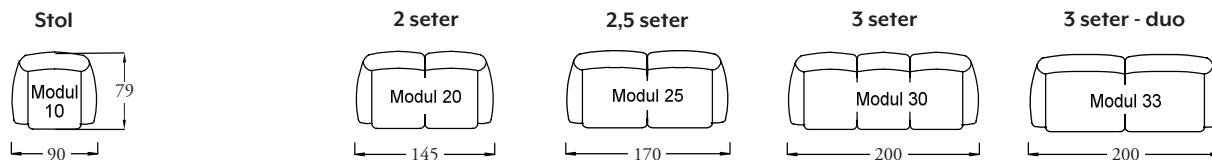

MODULER UTEN VANGER

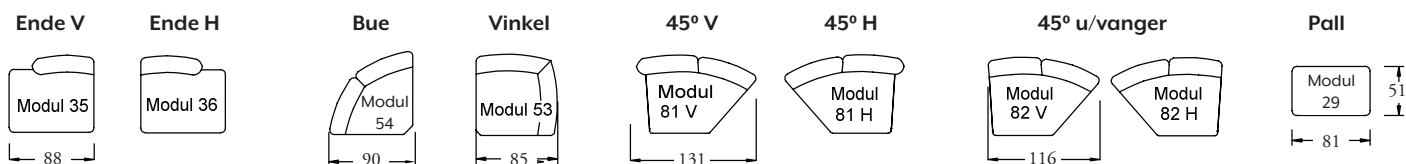
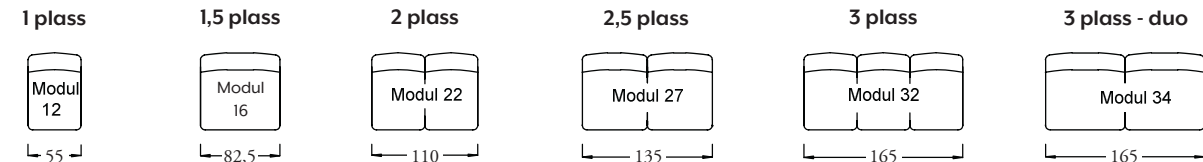
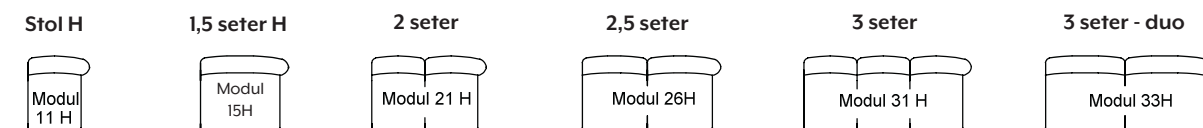
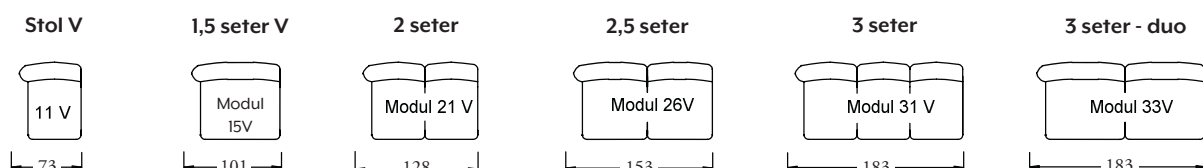

EKSEMPEL PÅ POPULÆRE OPPSETT

Når man velger oppsett 53, blir oppsettet 5 cm kortere i hver retning i forhold til oppgitte mål på tegningene. Vangebredden 18 cm er brukt på alle oppgitte mål.

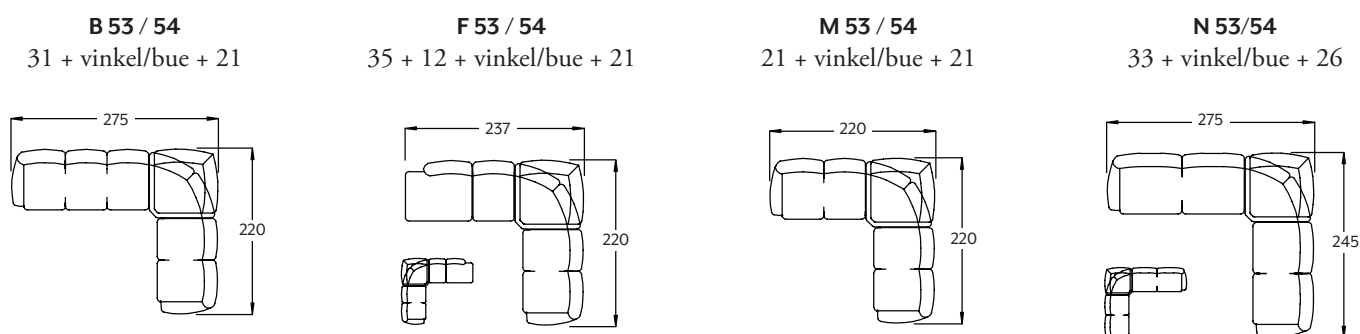

VANGER



AMI
17 cm



JULIA
14 cm



MALIN
18 cm

BEN

Ami: 5 cm ben både foran og bak

Julia og Malin: 13 cm ben



170 EIK
5/13 cm



370 EIK
5/13 cm



120 MATT KROM
5/13 cm

TREVERKSFARGER

Ben i eik kan fås i ulike farger/finisher.



Hvitoljet

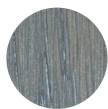

Gråoljet



Oljet



Wenge



Lyslakkert



Ubehandlet



Svartlakkert



Valnøtt

MÅL

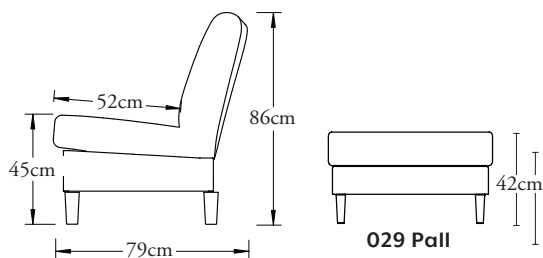

DESIGN DIN EGEN SYSTEM+

På brunstad.no kan du bygge System+ i 3D.
Sett på tekstil, hud og farger etter eget ønske.

10 ÅRS GARANTI

I Brunstad samarbeider vi med flere lokale produsenter, noe som gjør våre møbler både kortreiste og miljøvennlige. Vår kunnskap om materialbruk og systematisk testing av materialene gjør at vi gir deg 10 års garanti på både seteputer og rammeverk.

