

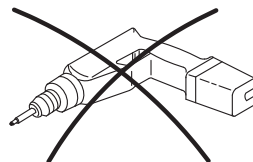

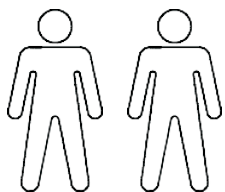

# Tampa 2.5-Seater

---

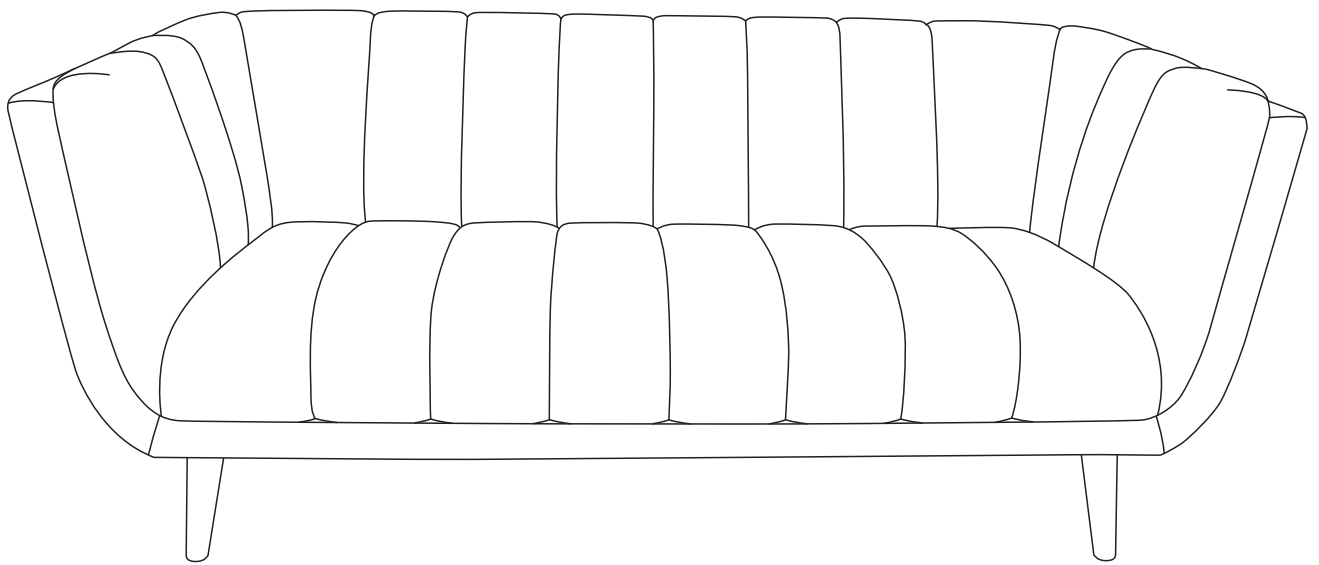
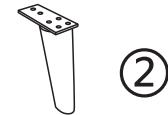
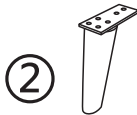
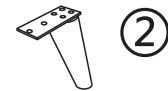
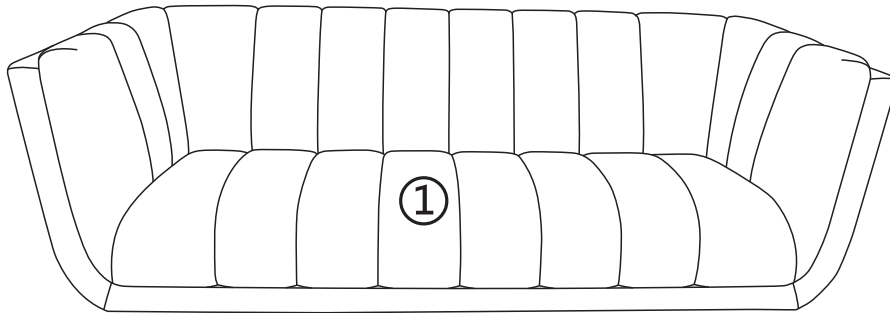

①	1	1840X865X565	
②	4	120X $\phi$ 60/ $\phi$ 32X200	

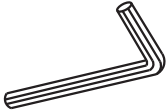

A x 8	B x 1	C x 4
		
M6x 20 mm	M4 x 70 mm	$\phi$ 28 x 3 mm

# 1

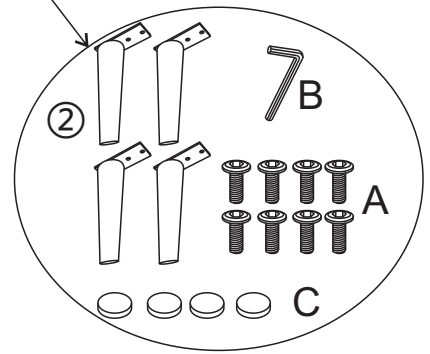
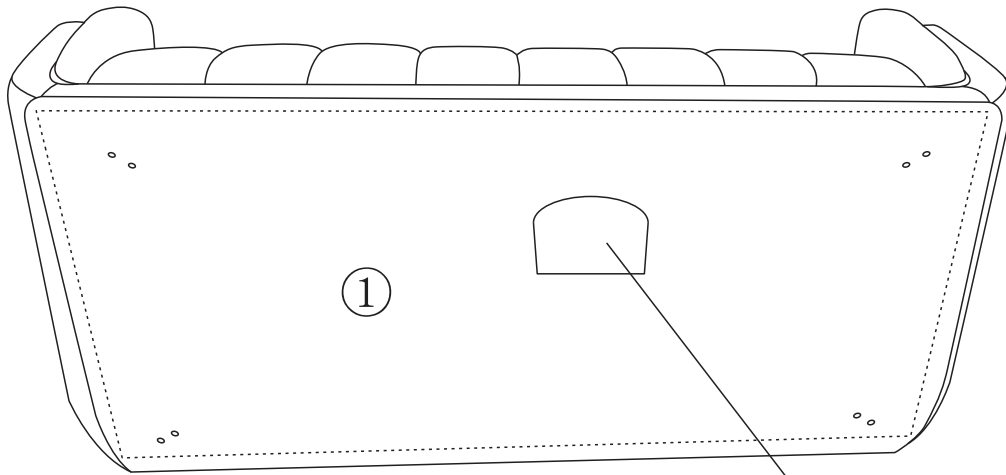

# 2

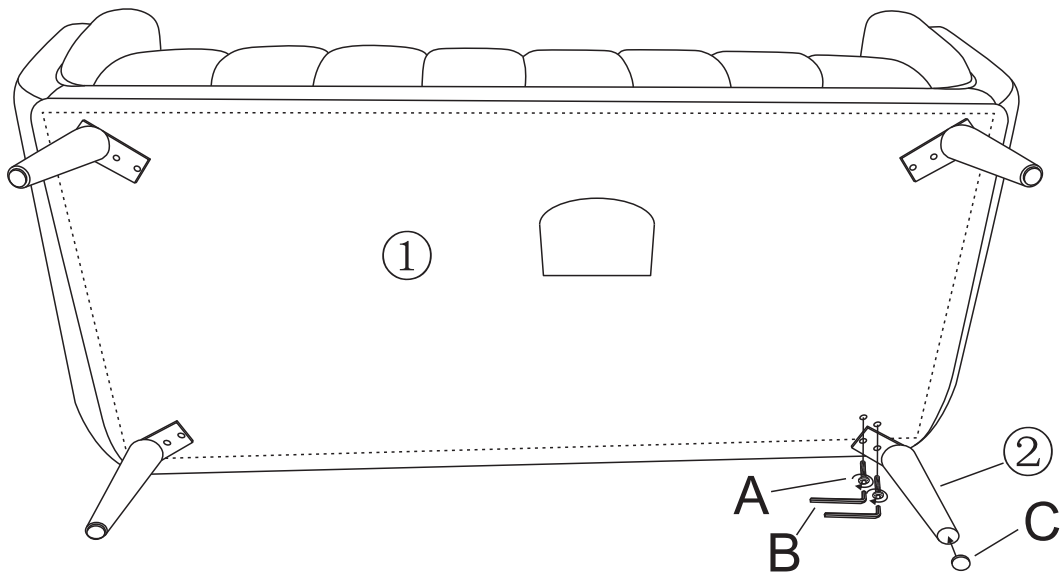
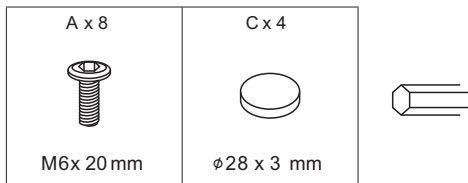

3

