

## CARRO STOL

CARRO chair



Delar / Parts



1

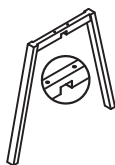

2

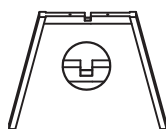

3



4

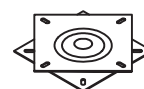

5

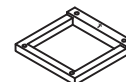

6

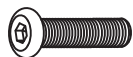

A x 6



B x 4



C x 12

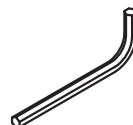

D x 1



E x 4

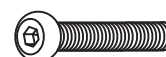

F x 2

# 1.

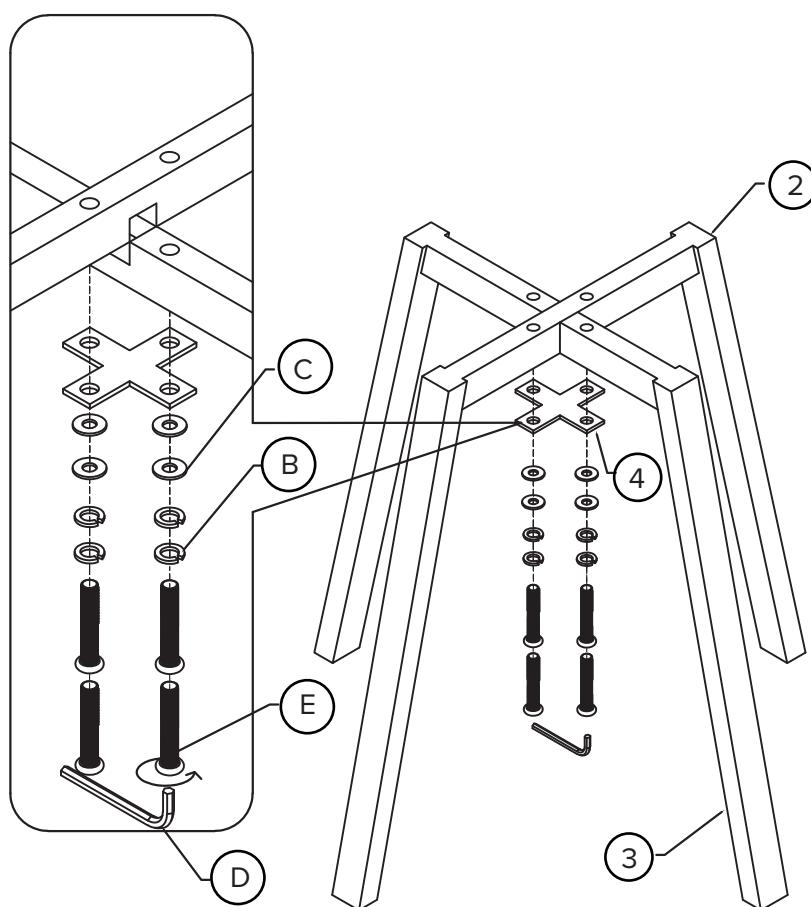

## CARRO STOL

CARRO chair



Delar / Parts



1

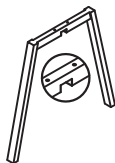

2

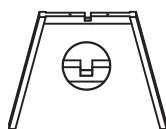

3



4

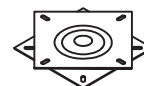

5

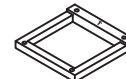

6

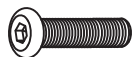

A x 6



B x 4



C x 12

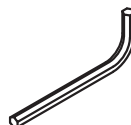

D x 1



E x 4



F x 2

## 2.

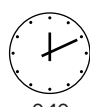
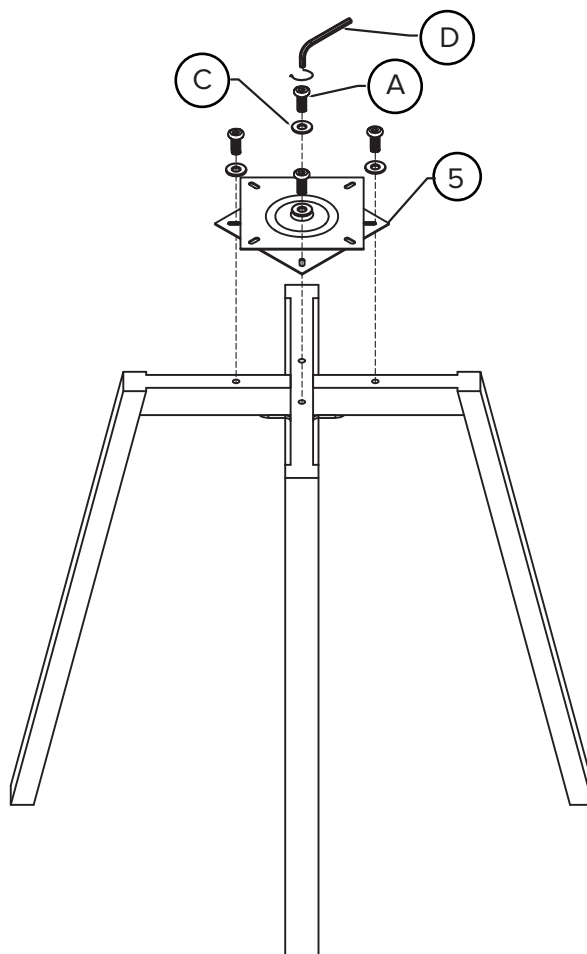

## CARRO STOL

CARRO chair



Delar / Parts



1



2

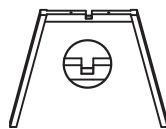

3

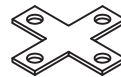

4

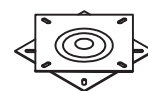

5



6

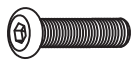

A x 6



B x 4



C x 12



D x 1



E x 4



F x 2

### 3.

