

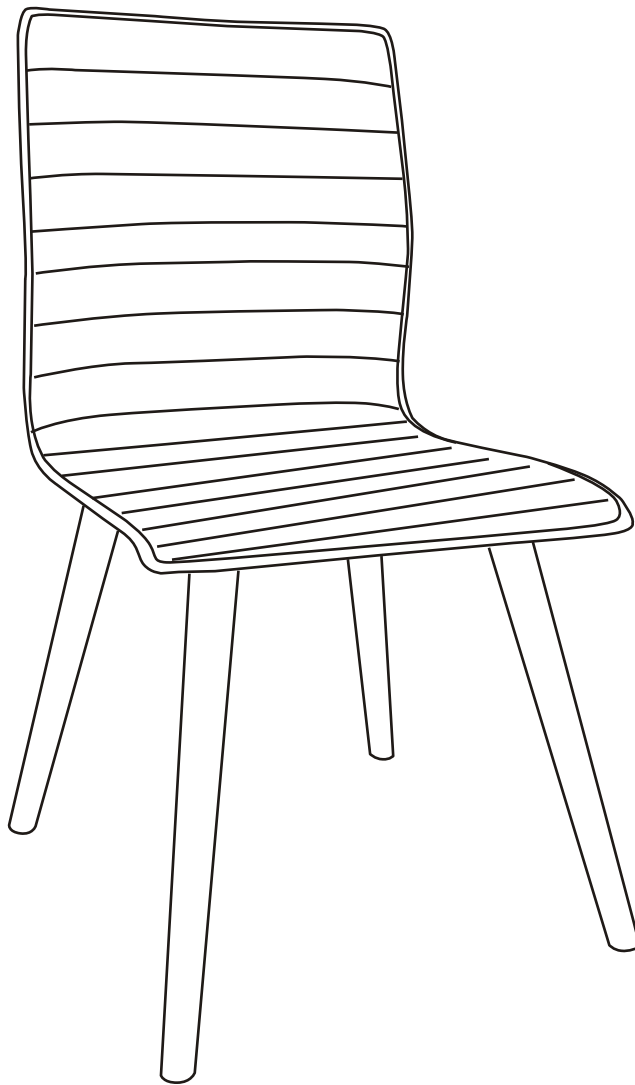









Karla





| | | | | |
|--|---|--|---|---|
| A*1  | B*2  42cm | C*2  44cm | D*1  | E*12  M6*14 |
| F*8  M6*25 | G*12  M6*13 | H*8  M6*16 | I*1  | J*4  |

1

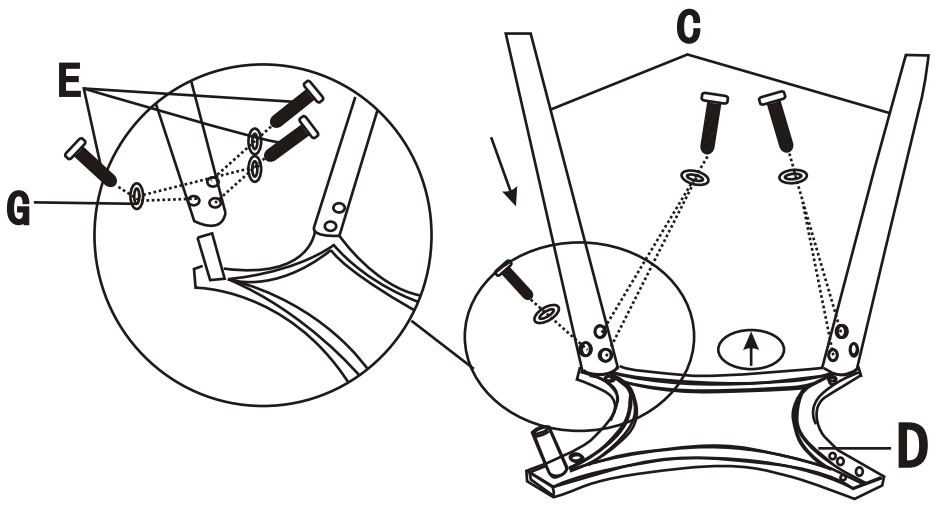
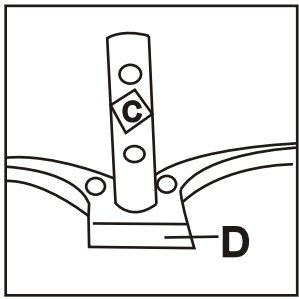
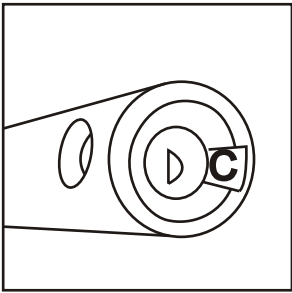
| | | |
|---|--|---|
| E*6  M6*14 | G*6  M6*13 | I*1  |
|---|--|---|





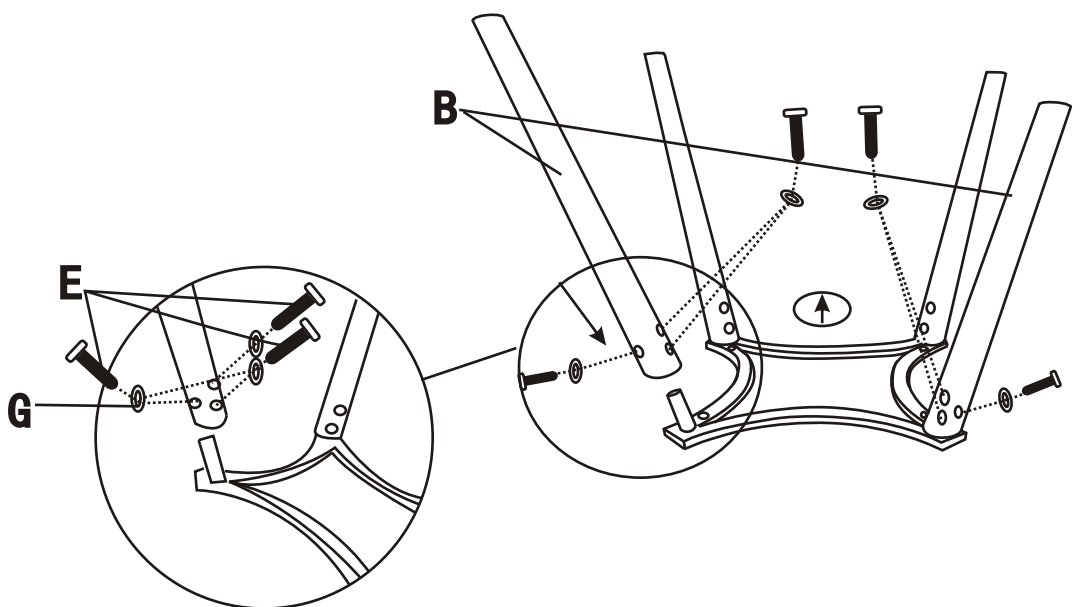
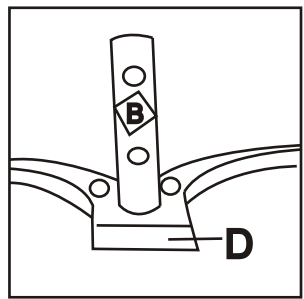
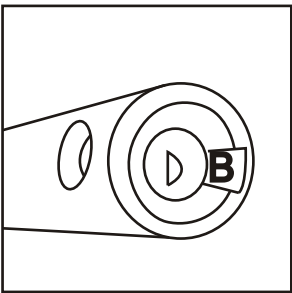

2

| | | |
|--|--|---|
| E*6  M6*14 | G*6  M6*13 | I*1  |
|--|--|---|



3

| | | | |
|---|---|---|---|
| F*8 | H*8 | I*1 | J*4 |
|  |  |  |  |
| M6*25 | M6*16 | | |

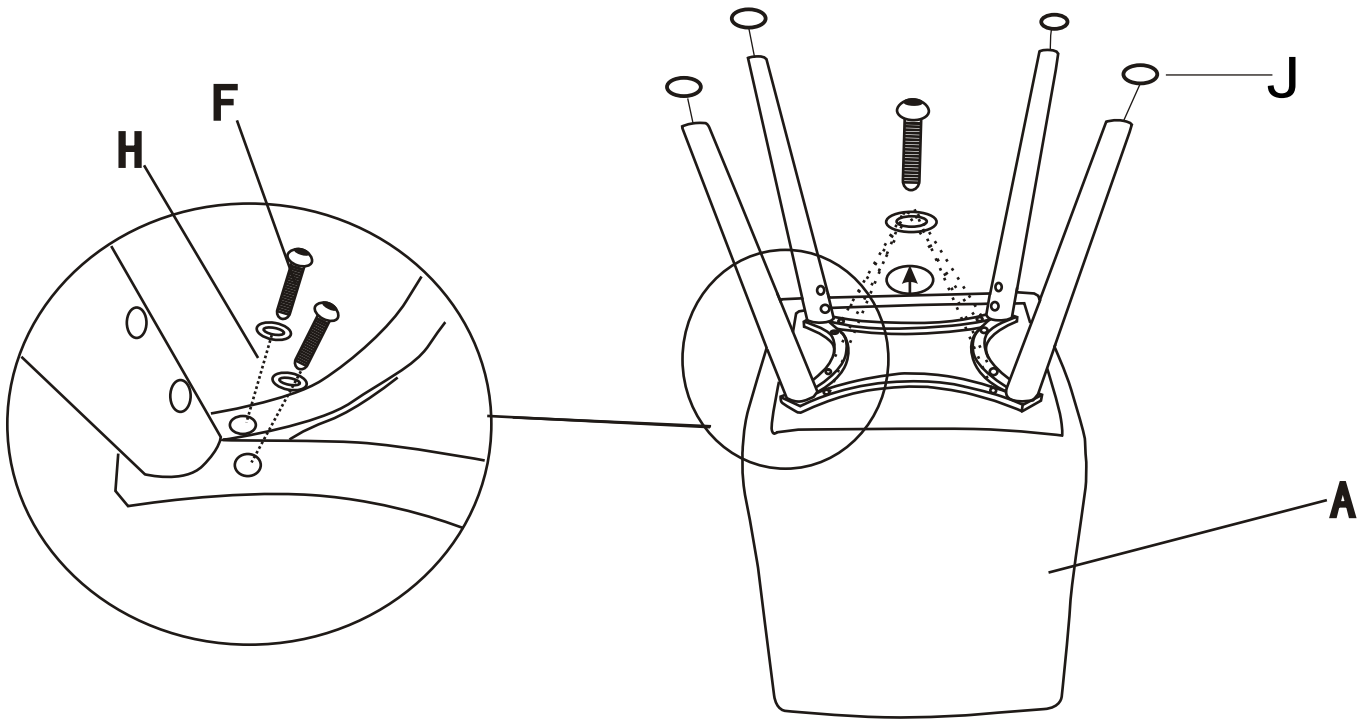

4

