







802 DINING TABLE INSTALLATION

components				parts				
A	table leg		×4	①	screw		M10*16	×12
				②	allen key		M8	×1
B	frame		×1	③	shim		*	×12
				C	table top		×1	

1

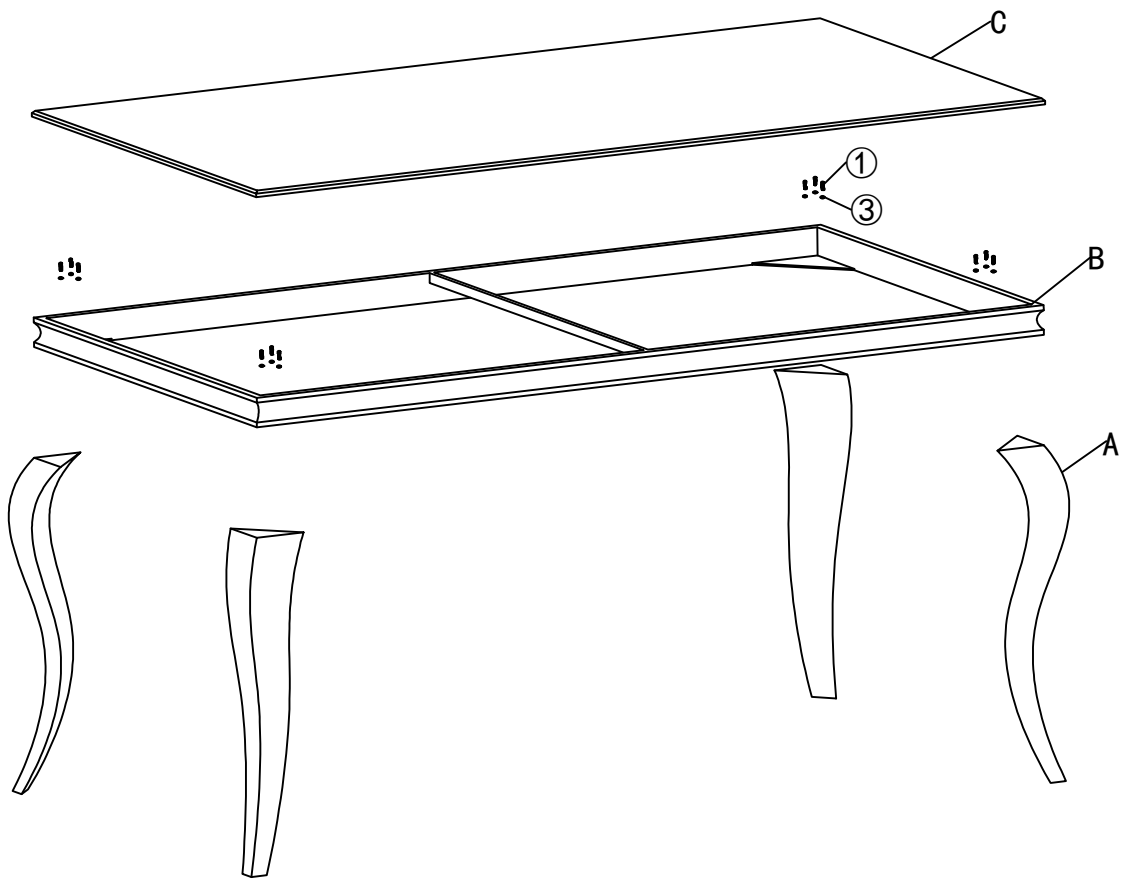

2

