

LÖDERUP VITRINSKÅP display cabinet/vitriinikaappi

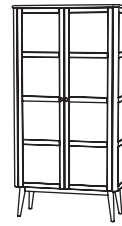

Delar/Parts/Osat

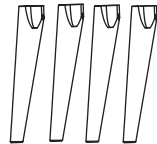

(A) x4



(B) x4



(C) x4



(D) x4



(E) x4

1.

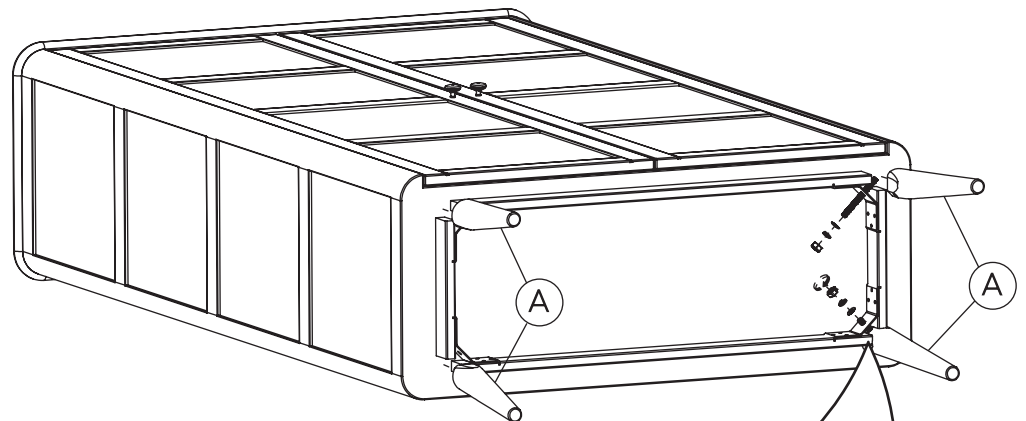
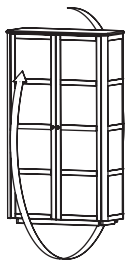

2.

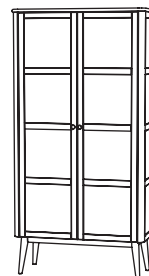
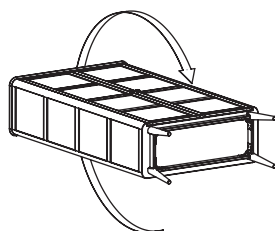

www.torkelson.se



0:30

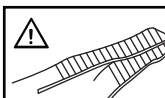

För att förhindra att möbelen väter måste medföljande väggfäste användas. /To prevent tip over this furniture must be used with attached wall attachment./Kalusteiden kaatumisen estämiseksi on välttämätöntä mukana toimitettua seinätelinettä voidaan käyttää.