











# MARTINSEN

## Assembly Instructions for item: 20210106/20210148

Safety warning: If you don't understand these directions or have any doubt about the safety of installation, our customer service representatives can quickly assist you with installation questions. Check carefully to make sure that there are no missing or defective parts. Replacement parts for products purchased through authorized dealer will be shipped directly to you. Never use defective parts. Improper installation may cause damage or serious injury.

Thank you for choosing Martinsen Furniture.



SKETCH	GAUGE	QTY	
A 		1	 DO NOT USE EL DRILL
B 		1	
① 	M6×30mm	4	
② 		4	
③ 		4	
④ 	M5	1	

### Step1

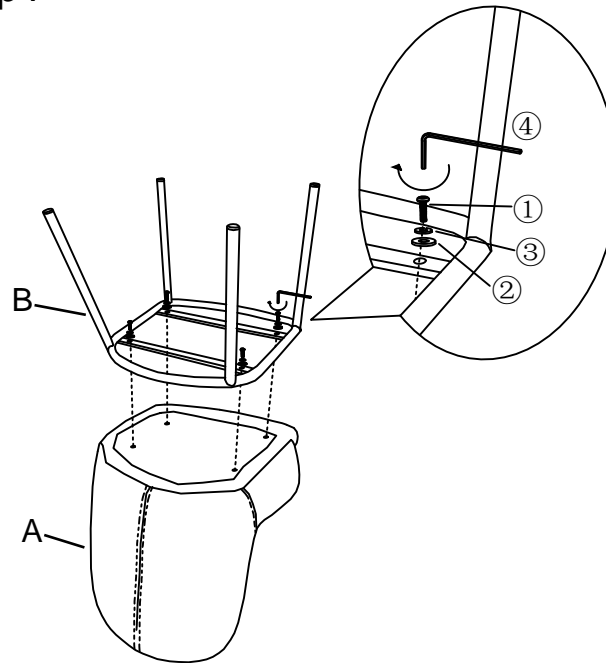

Step1 : Use screws to connect seat bottom and leg base one by one and 50% tighten at this stage.

### Step2

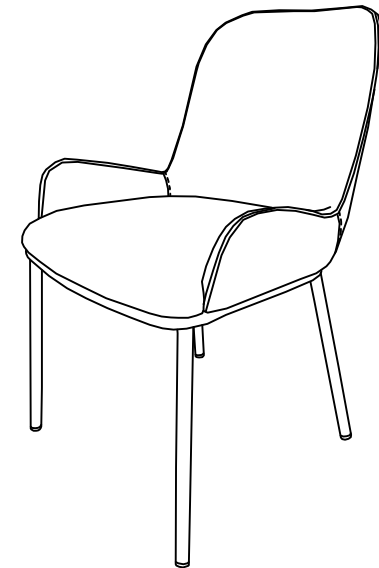

Step2 : After all parts are in right position, 100% tighten up all screws before using.