

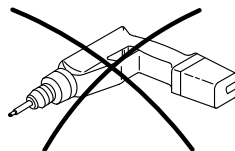

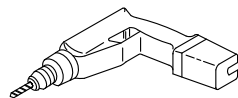

STRINGTON

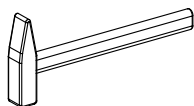

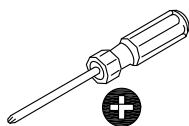
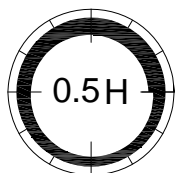
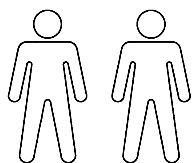
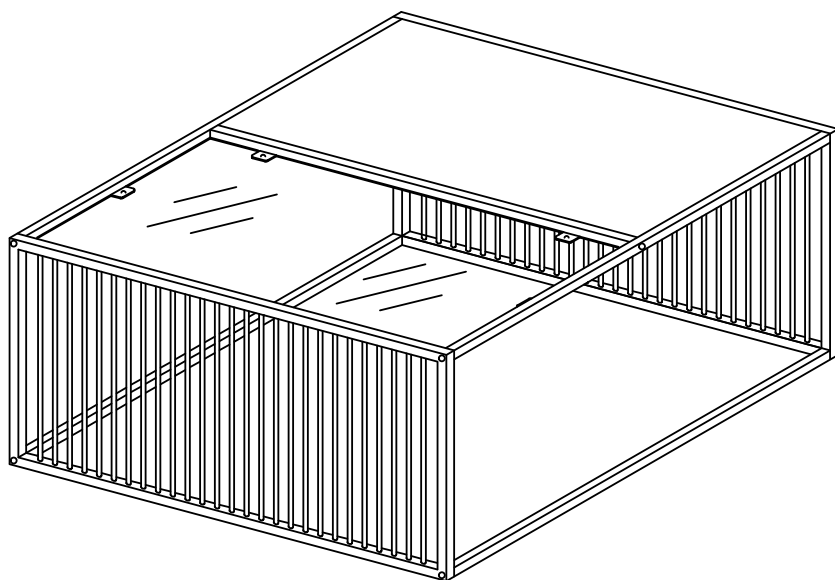
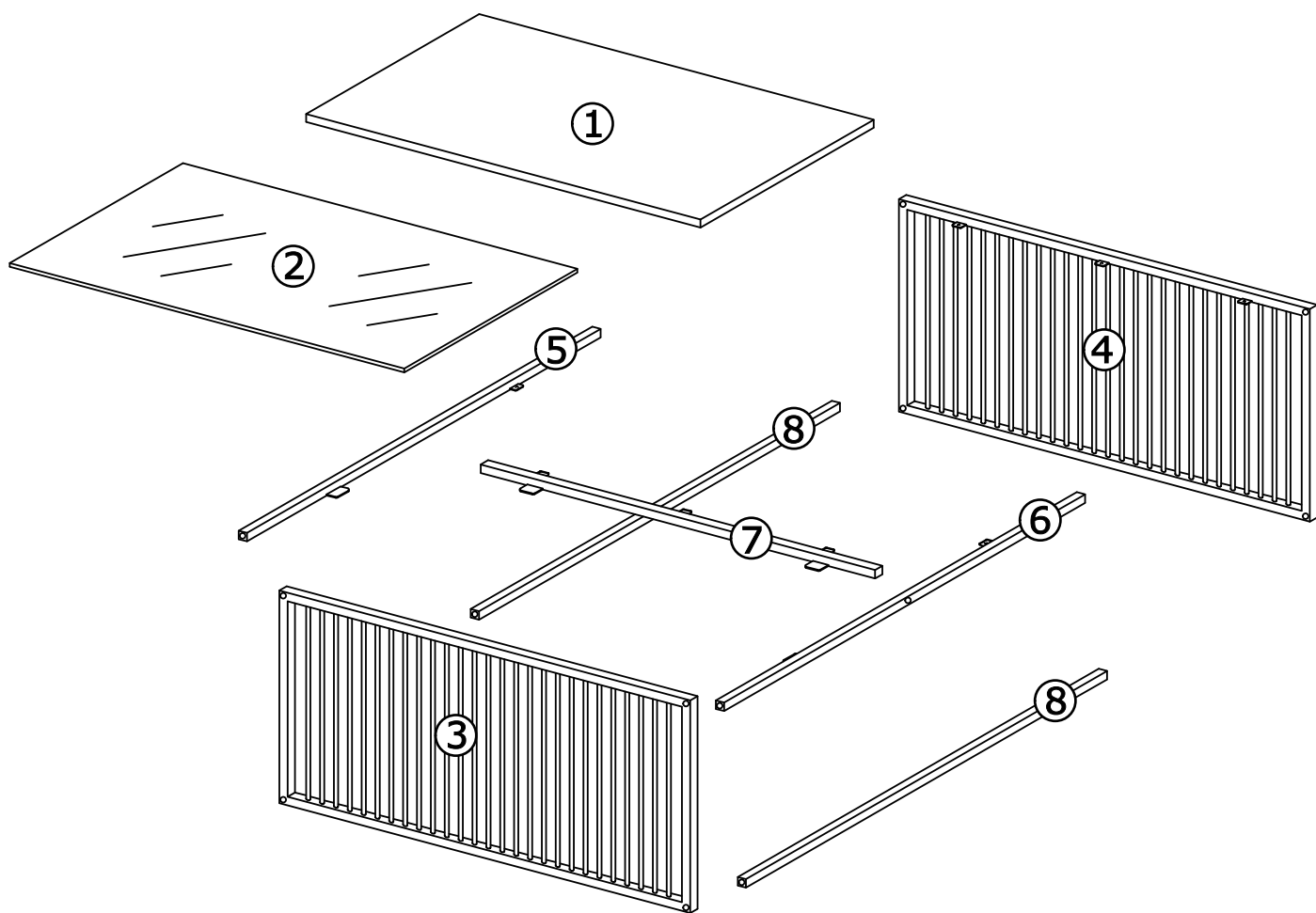

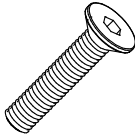
			✓
①	1	767x375x12	
②	1	767x375x5	
③	1	800x400x26/16	
④	1	800x400x42/16	
⑤	1	768x42x16	
⑥	1	768x42x16	
⑦	1	768x52x16	
⑧	2	768x16x16	

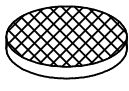

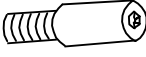

<p>A x 8</p>  <p>M6×15mm</p>	<p>B x 8</p>  <p>Ø4×12mm</p>	<p>C x 2</p>  <p>M6×30mm</p>	<p>D x 1</p>  <p>4mm</p>
<p>Ex 6</p>  <p>Ø8x1 mm</p>	<p>F x 6</p>  <p>Ø15x3 mm</p>		

1

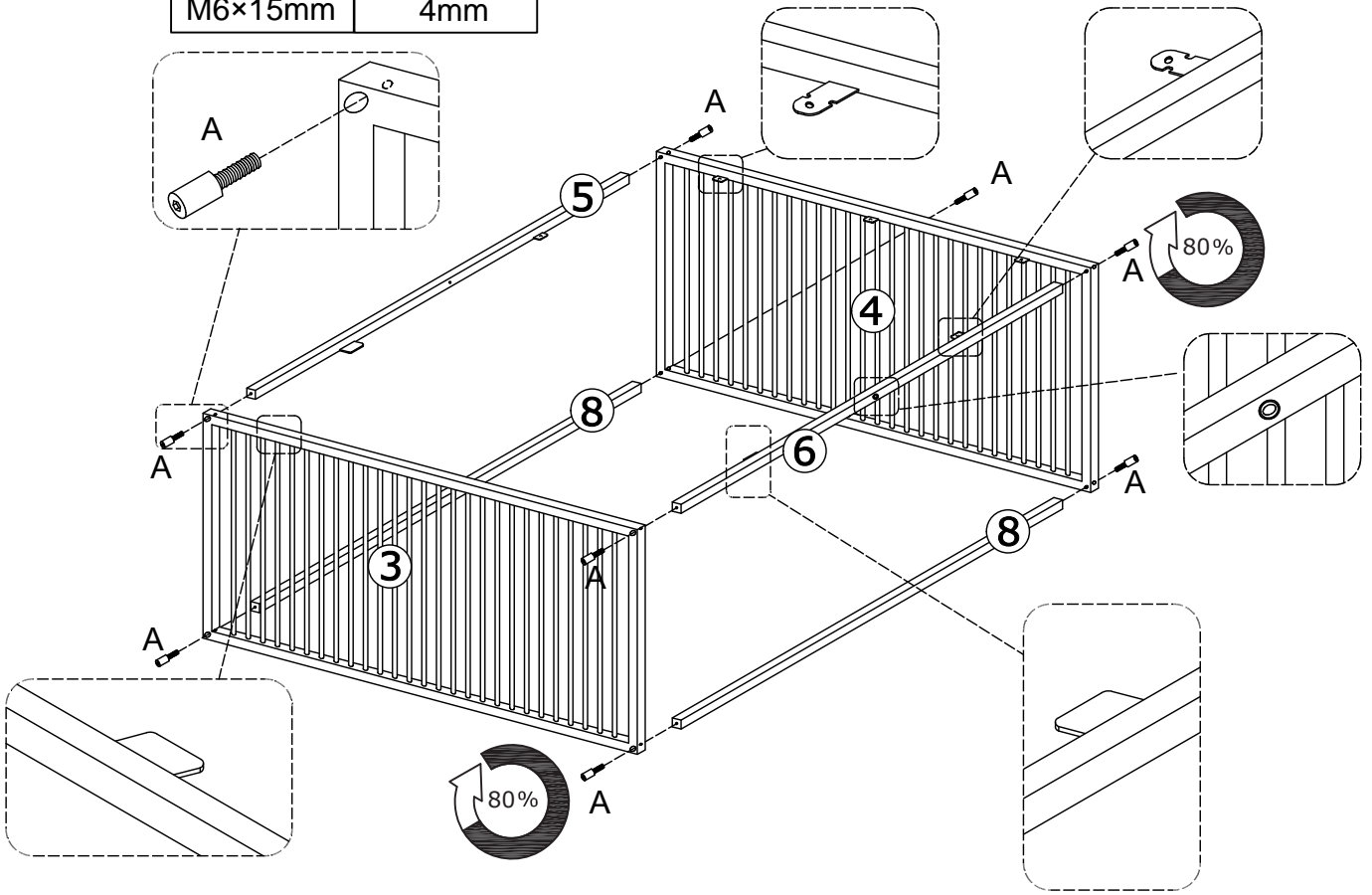
A x 8  M6x15mm	D x 1  4mm
---	---



2

C x 2  M6x30mm	D x 1  4mm
---	---

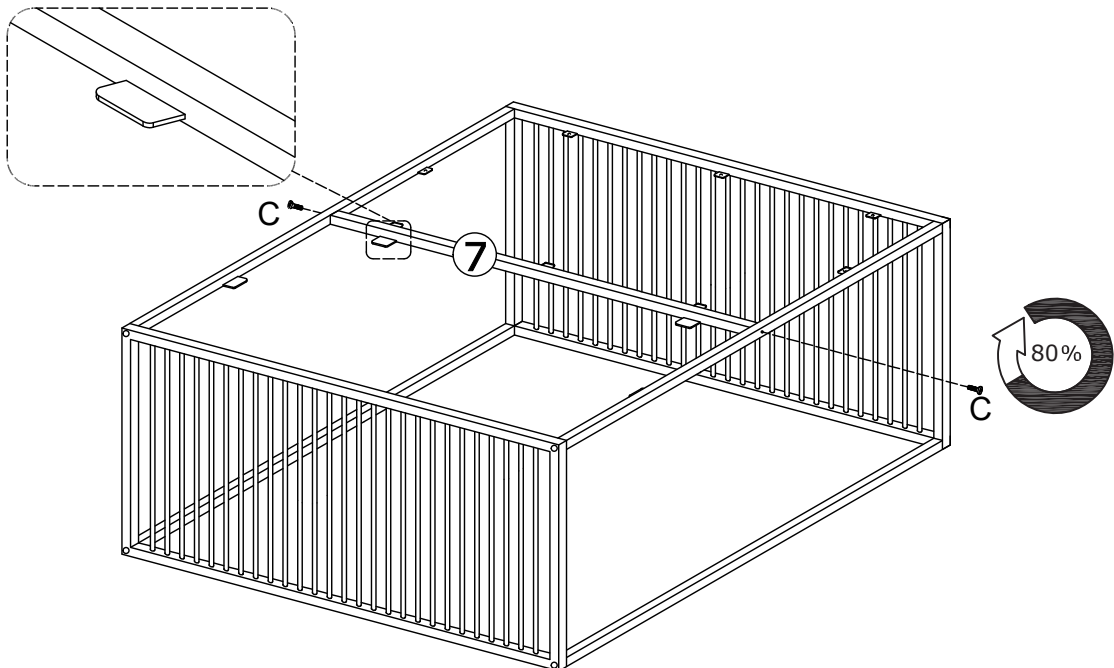

3

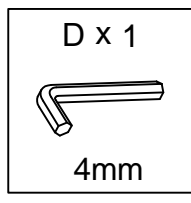

XX=YY

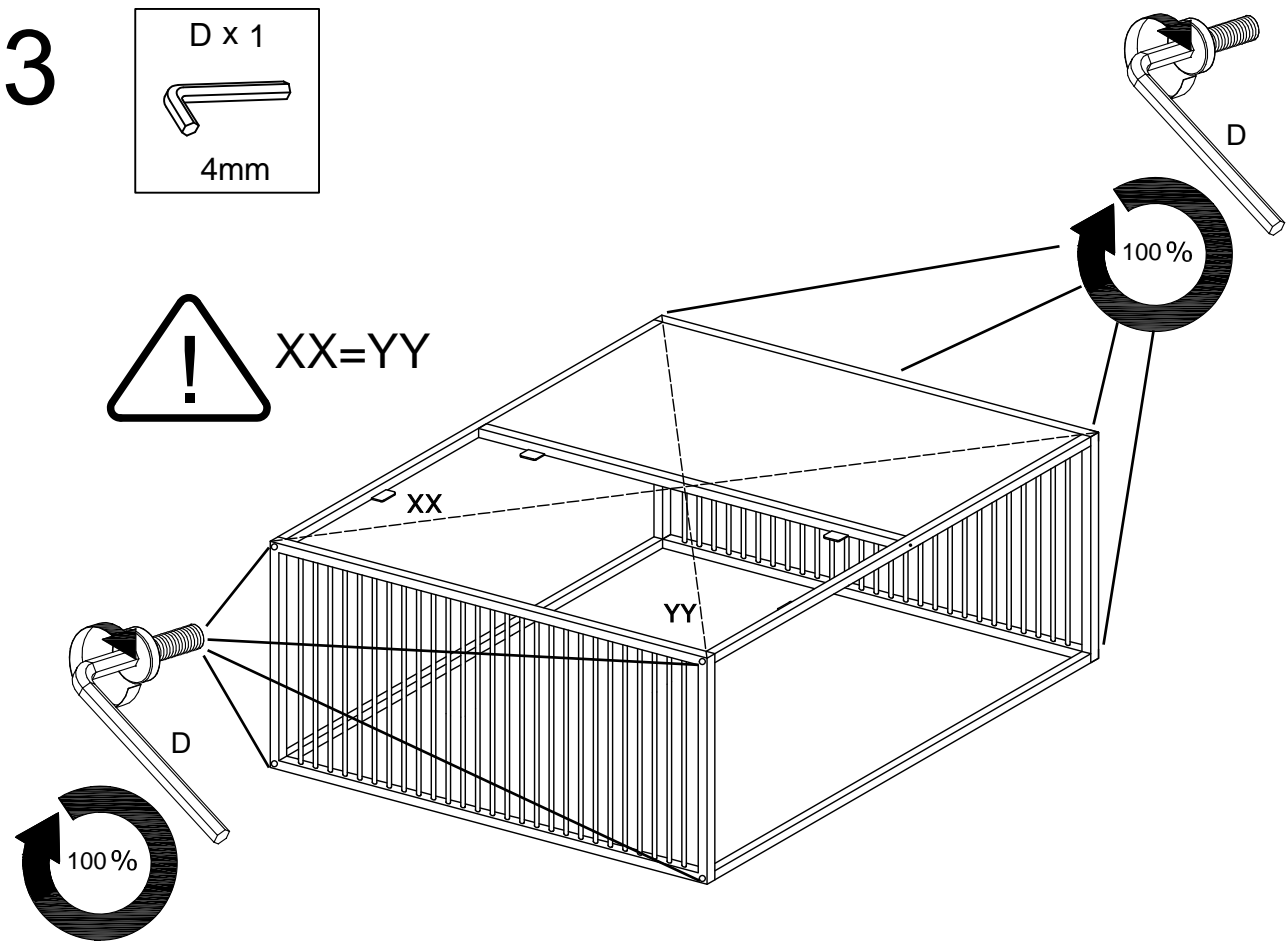

4

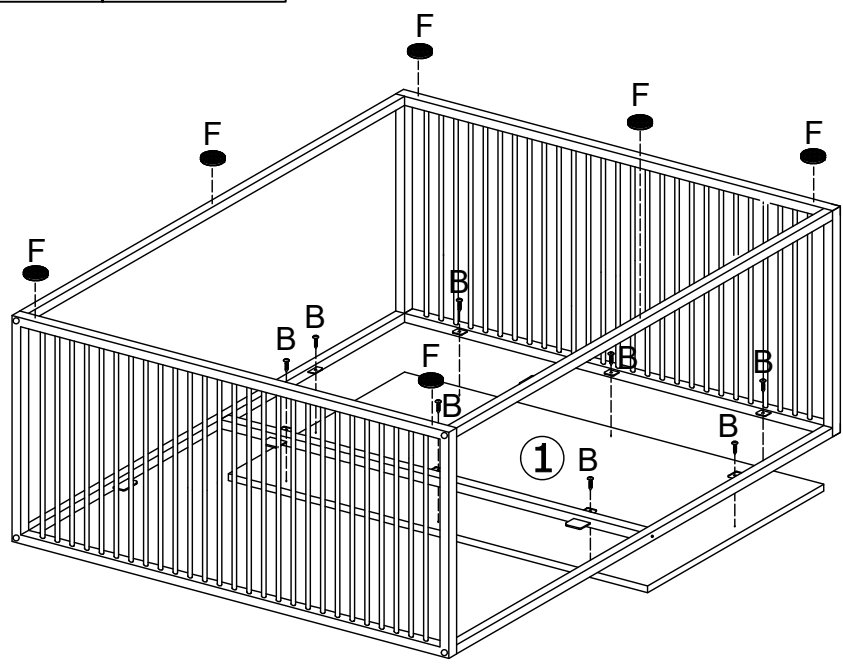
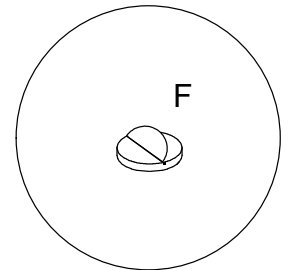
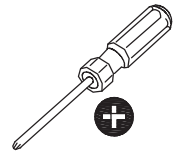
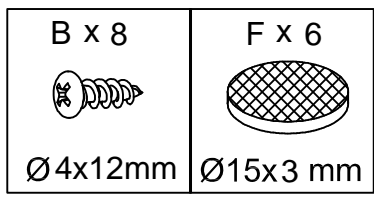

5

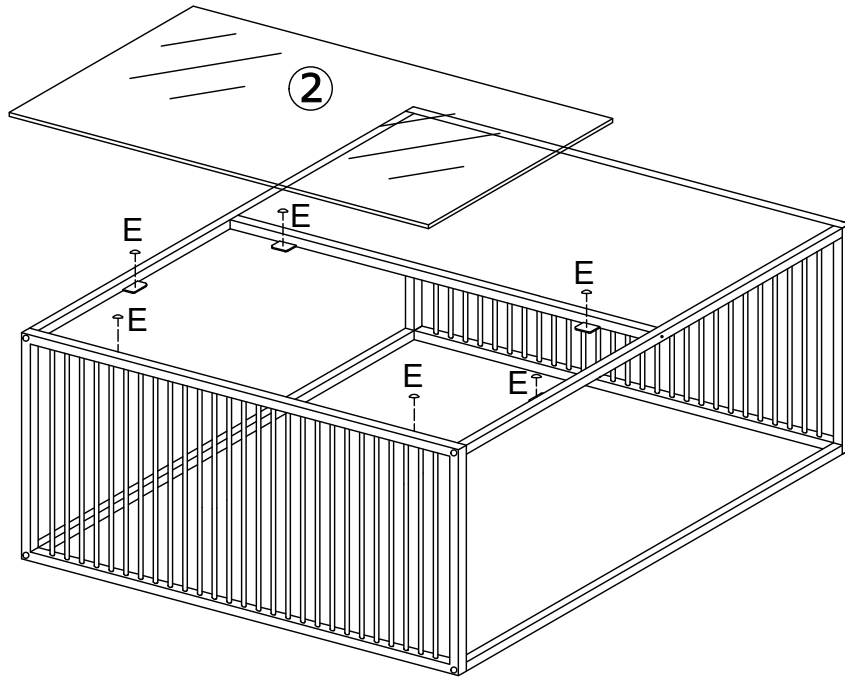
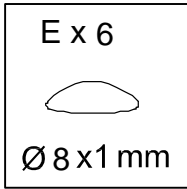

6

