

# MARIGOLD ASSEMBLY INSTRUCTIONS

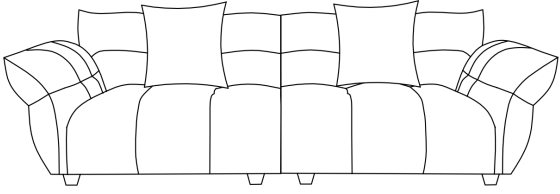

Option 1

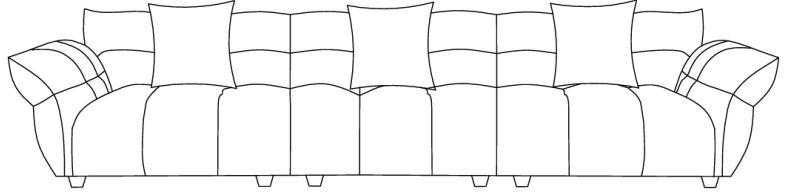

Option 2

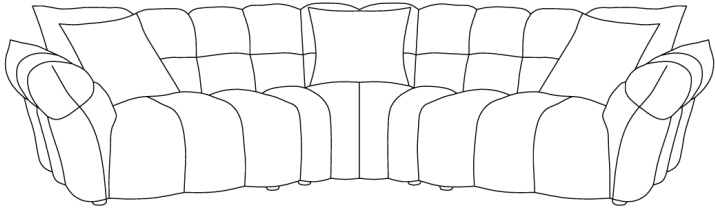

Option 3

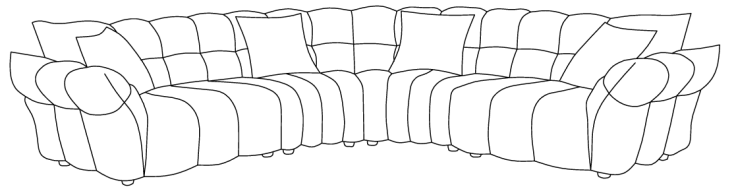

Option 4

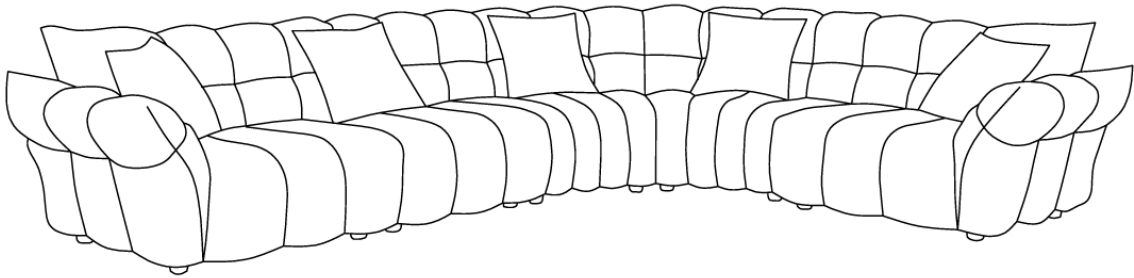

Option 5

Option 1

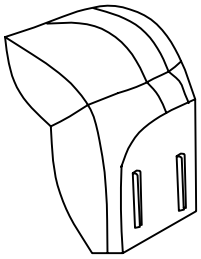
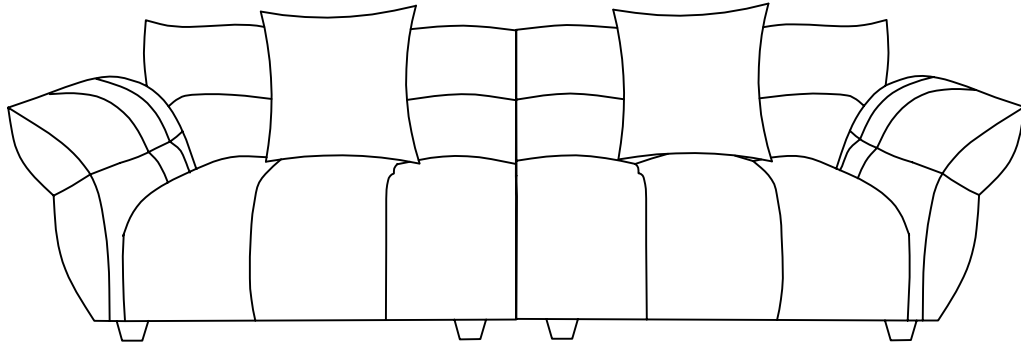

Ax1

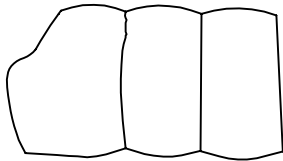

Bx1

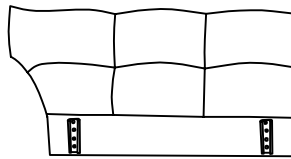

Cx1

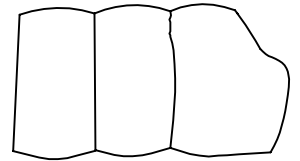

Dx1

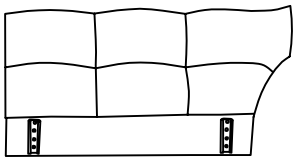

Ex1

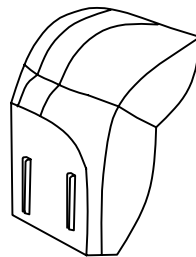

Fx1

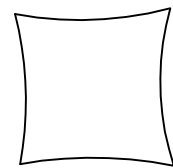

Gx2

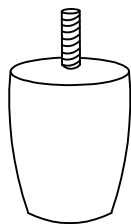

(1)x8



(2)x3

1

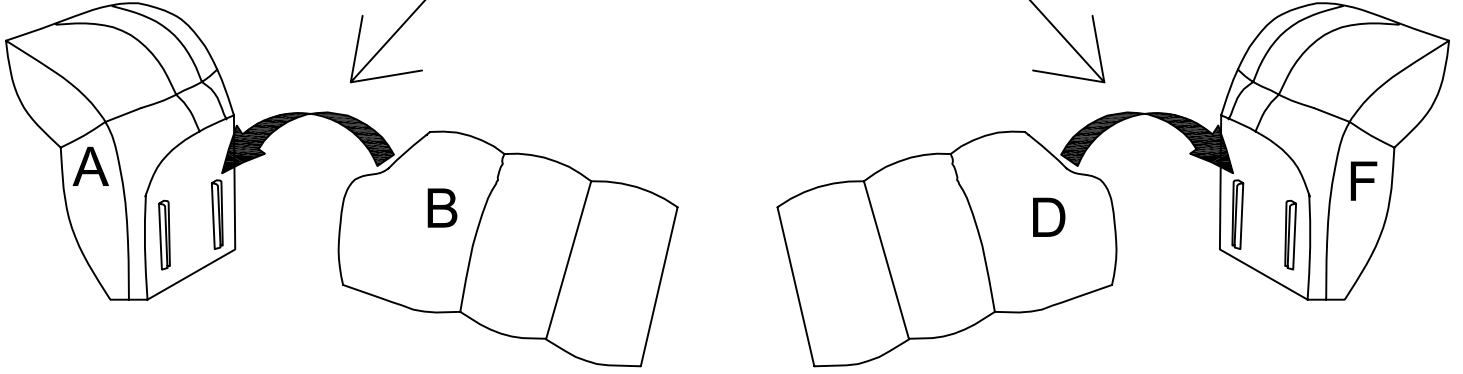
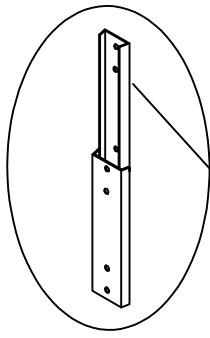

2

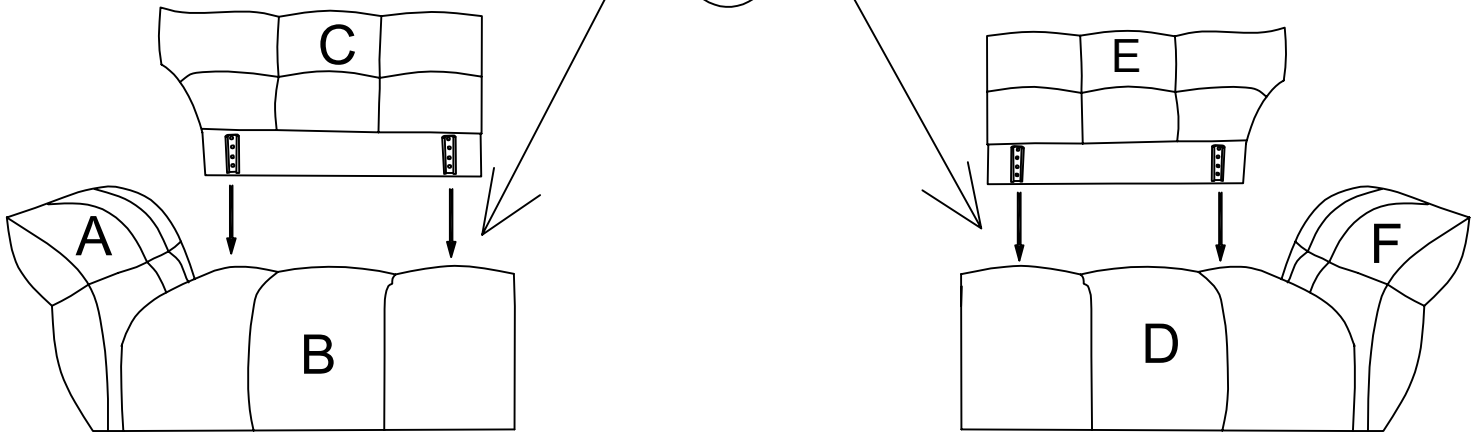
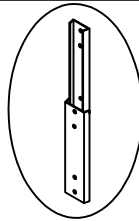

3

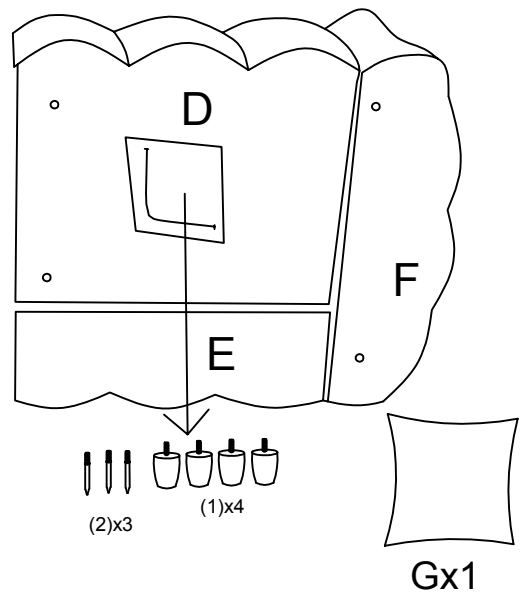
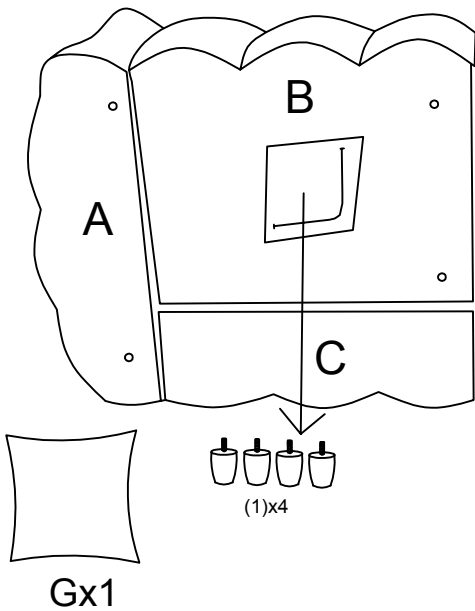

4

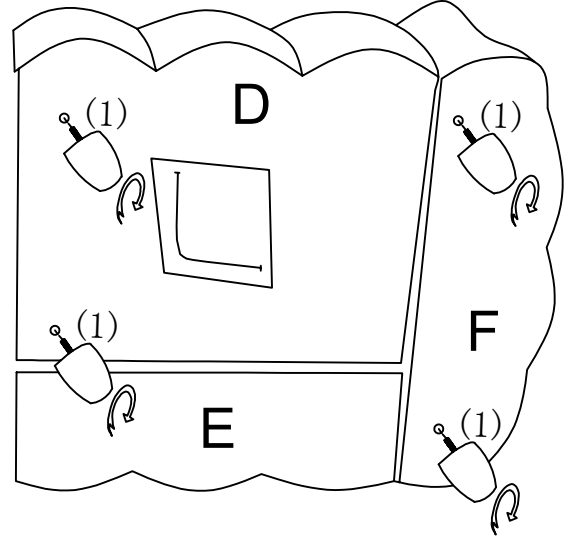
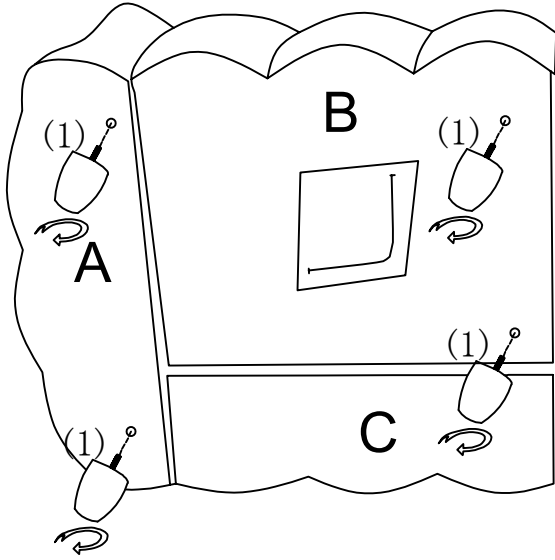

5

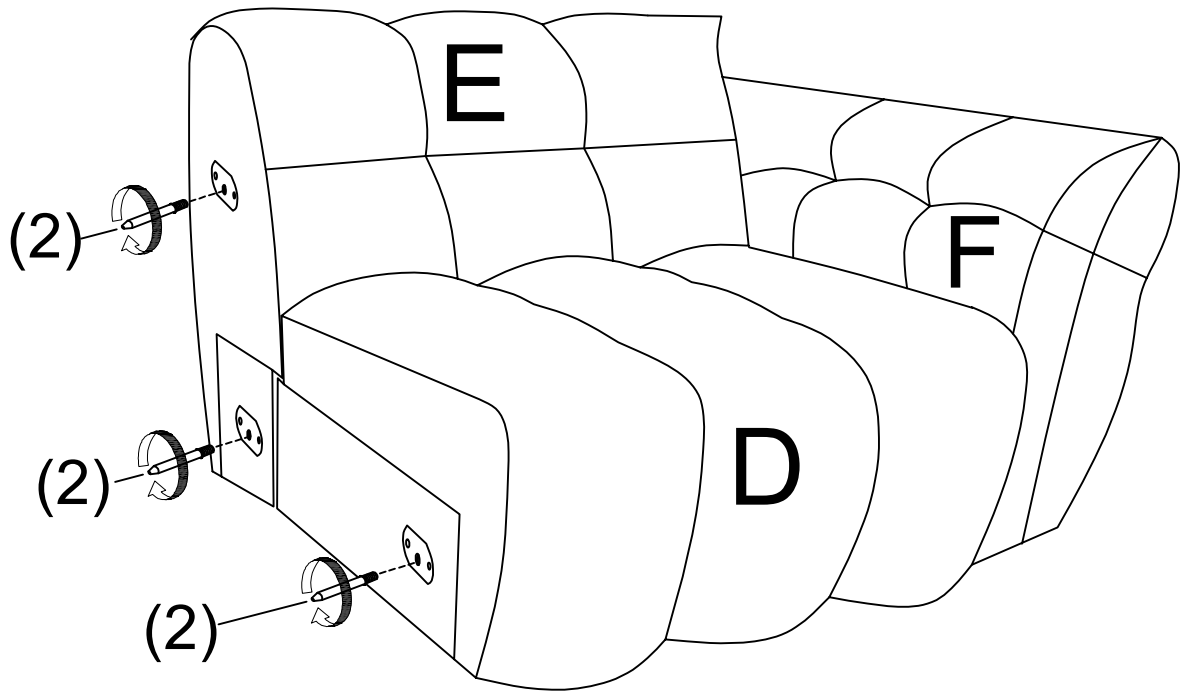

6

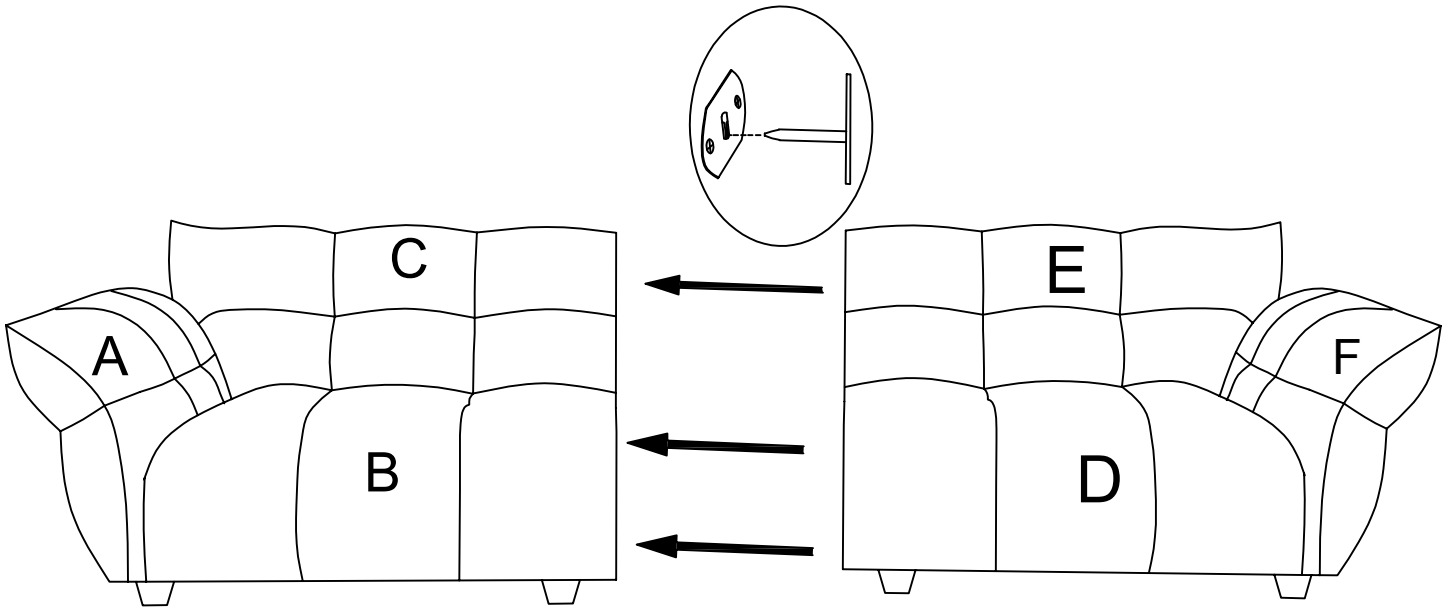

7

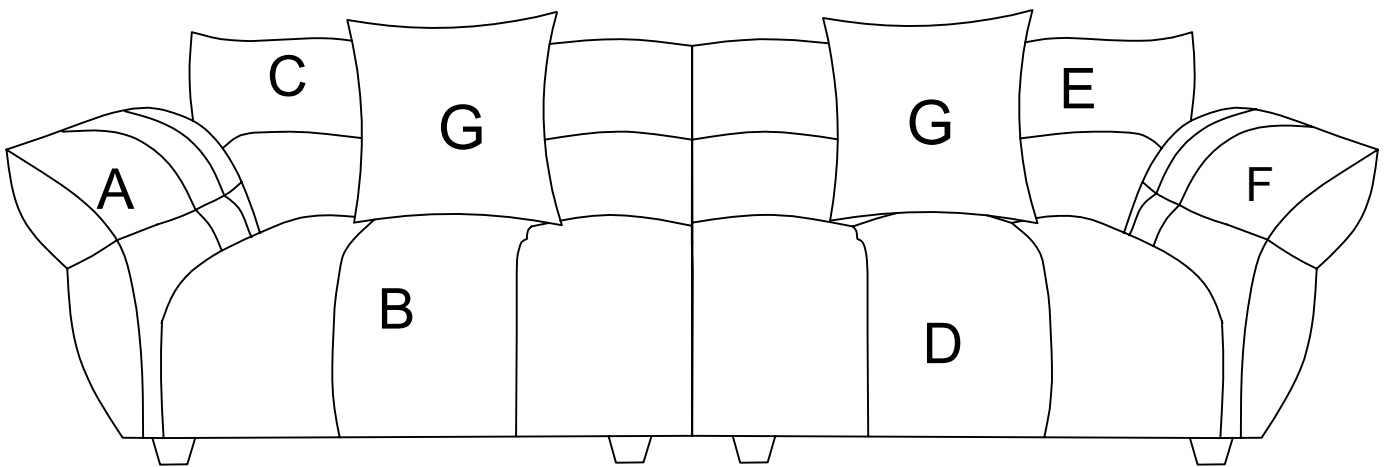

Option 2

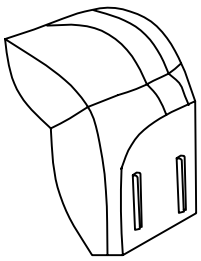
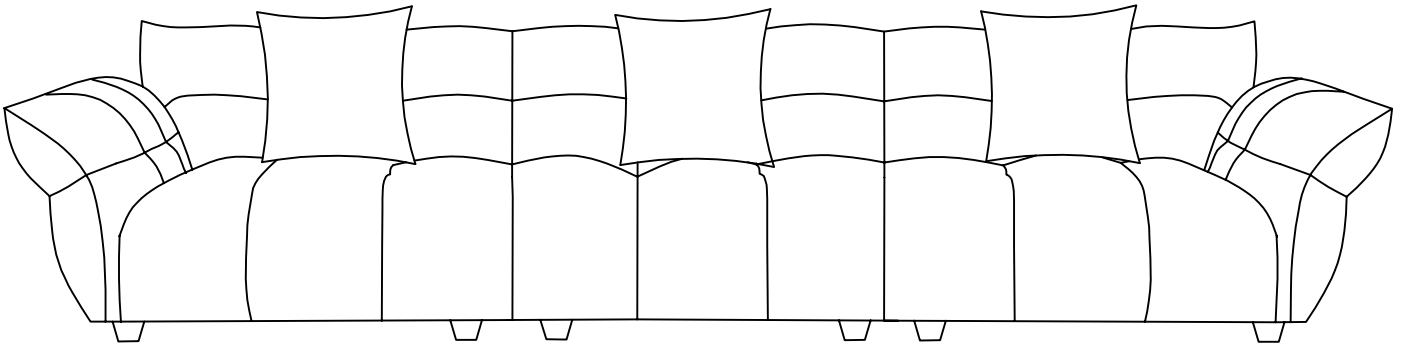

Ax1

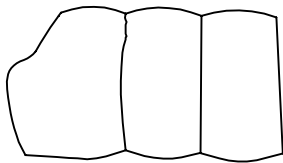

Bx1

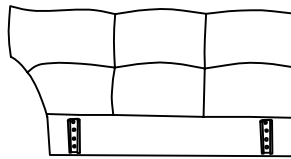

Cx1

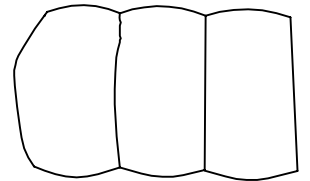

Dx1

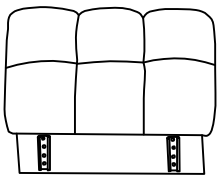

Ex1

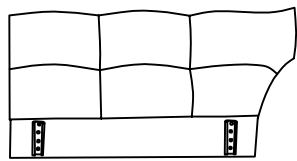

Fx1

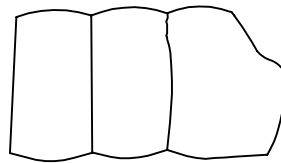

Gx1

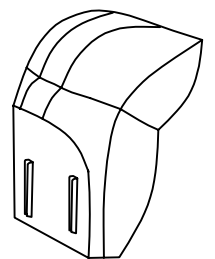

Hx1

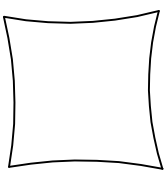

Ix3

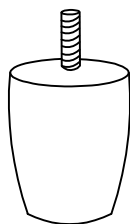

(1)x12



(2)x6

1

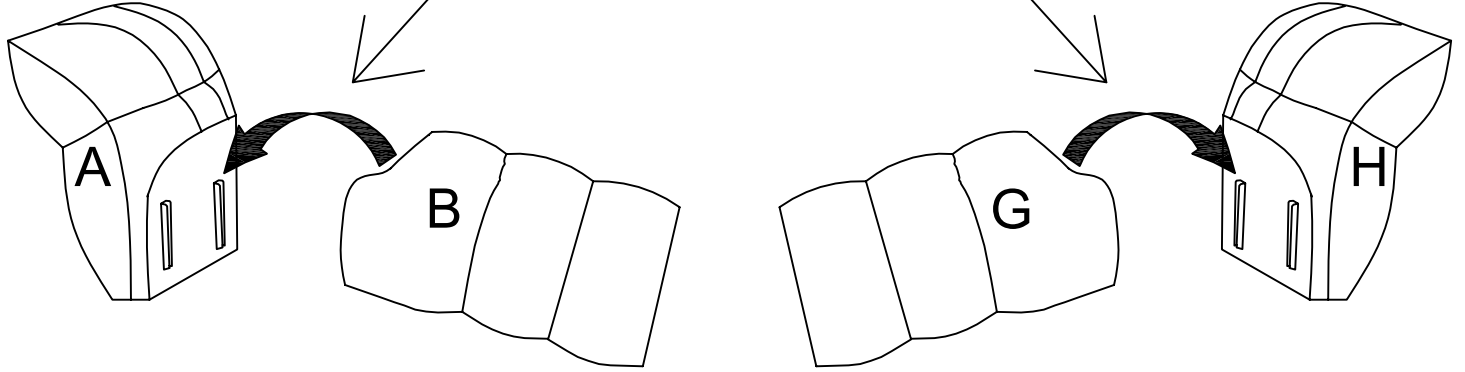
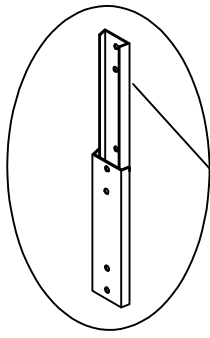

2

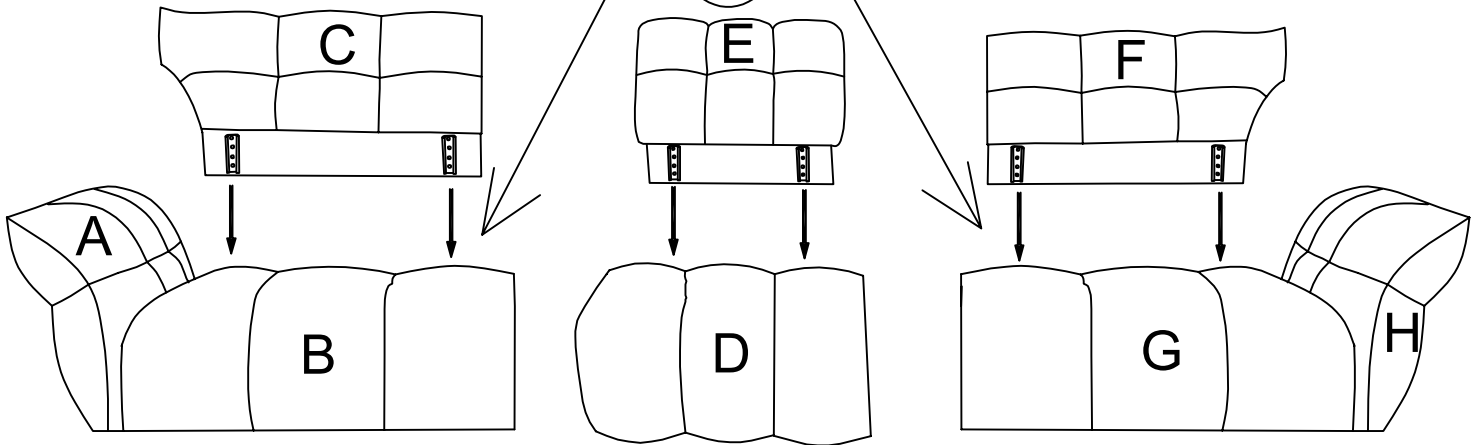
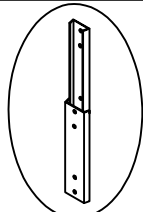

3

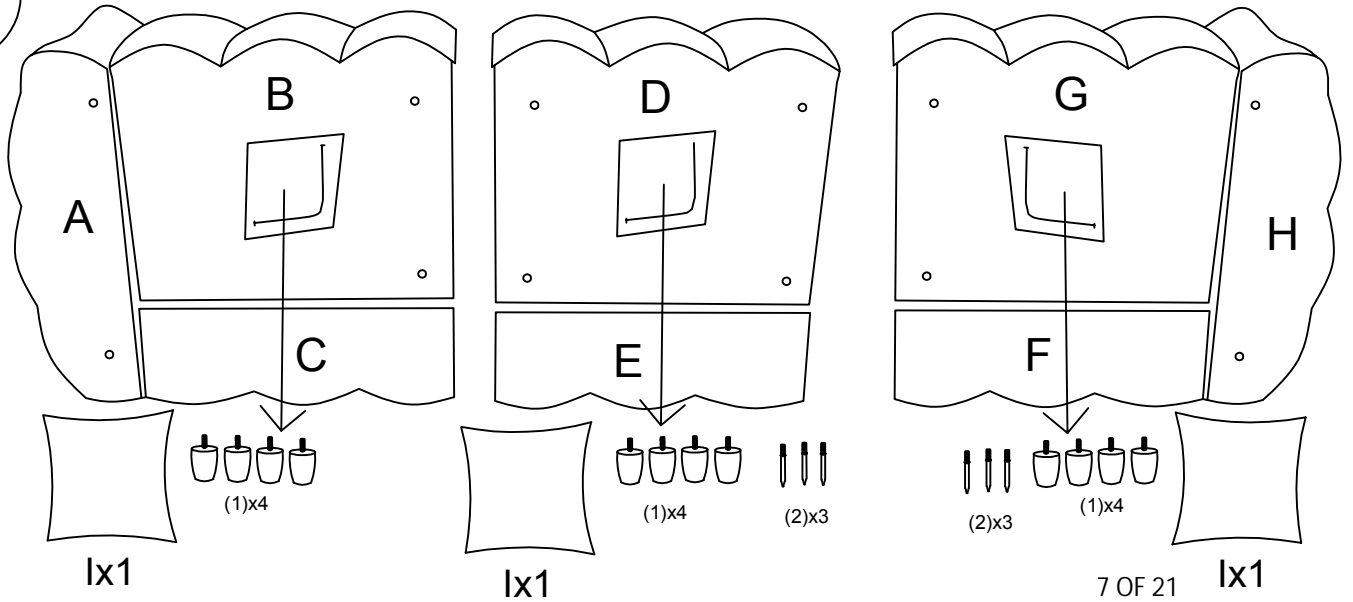

4

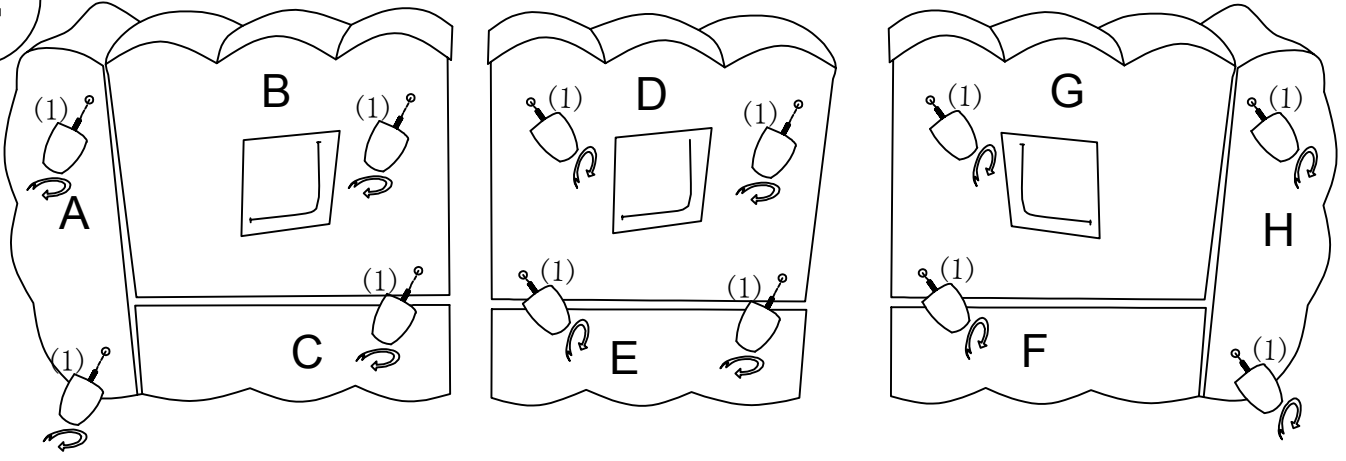

5

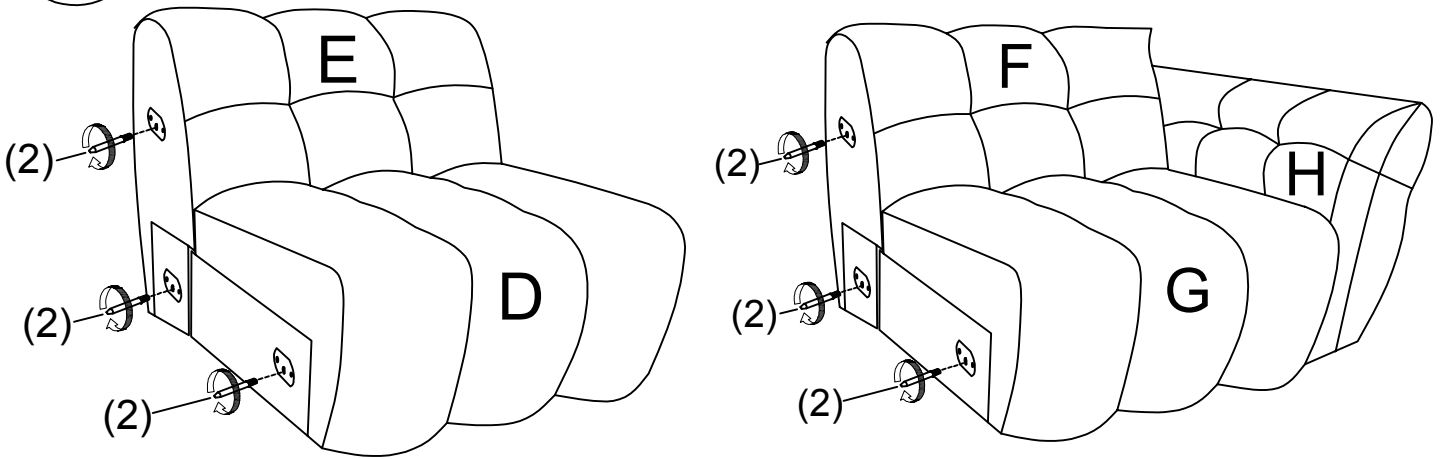

6

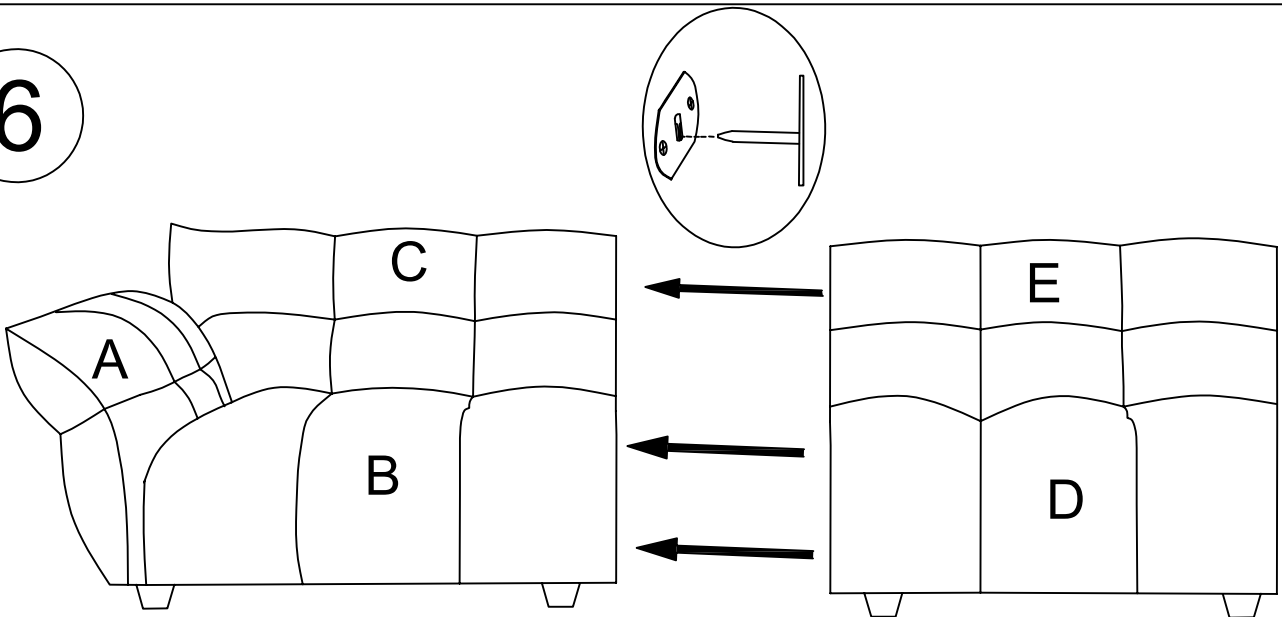

7

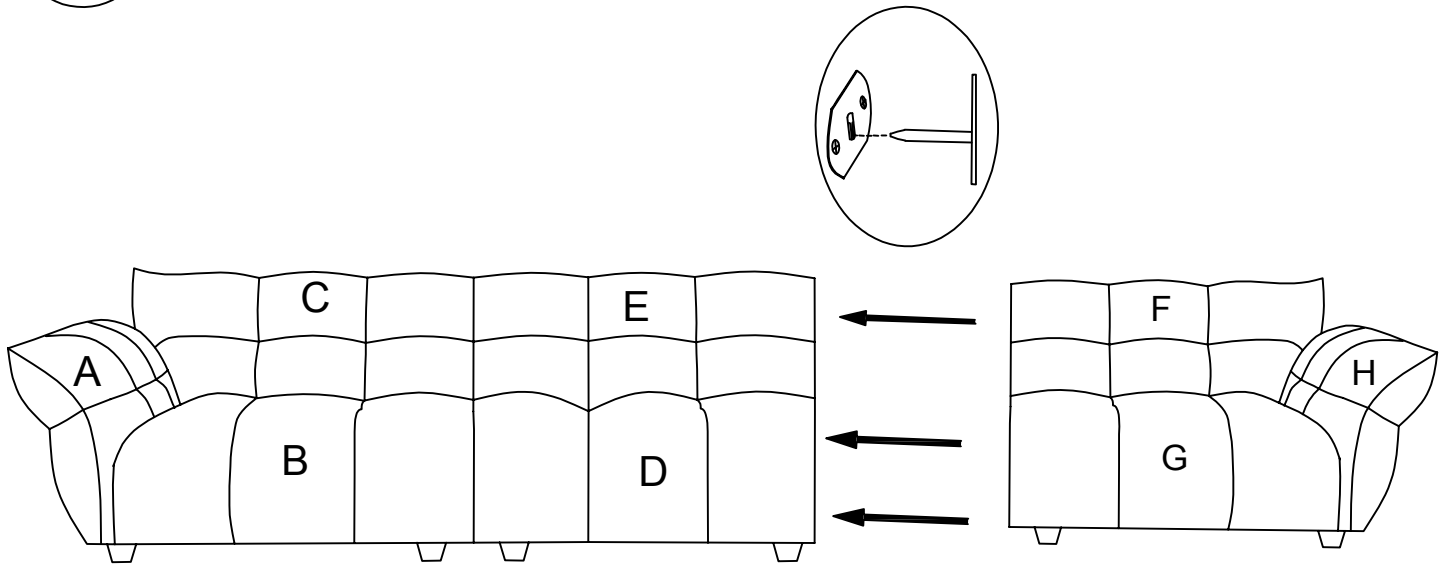

8

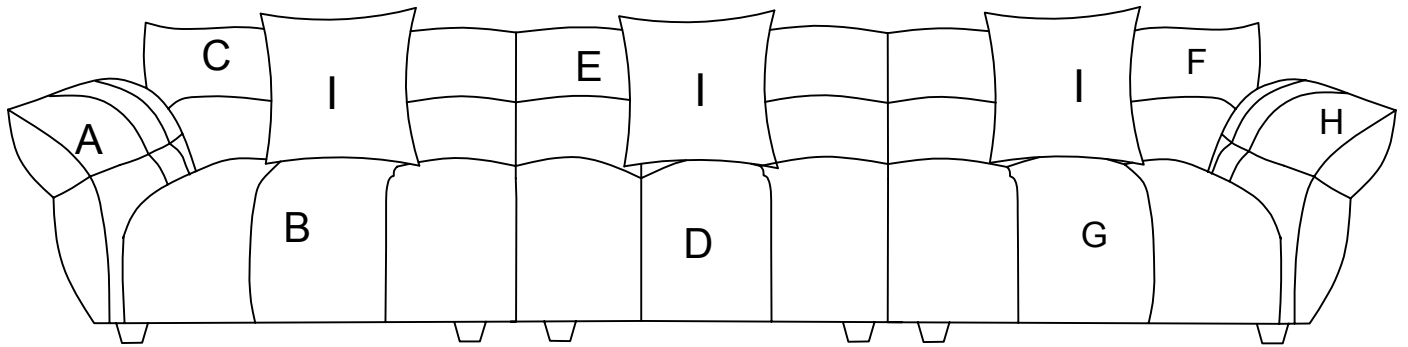

# Option 3

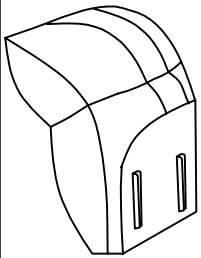
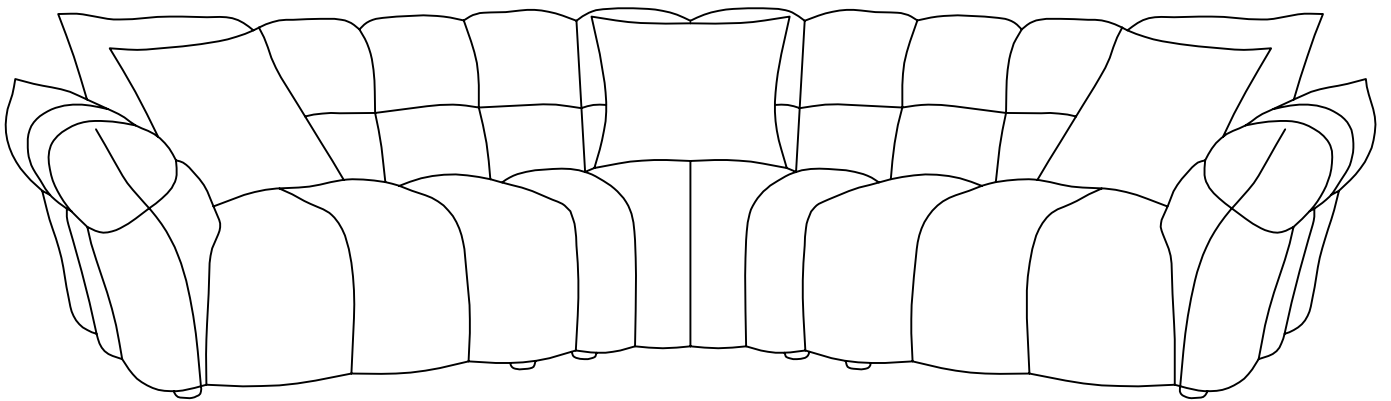
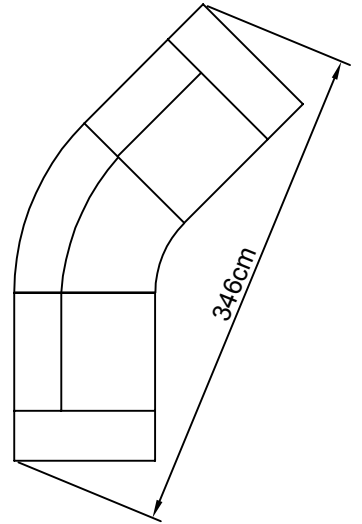

Ax1

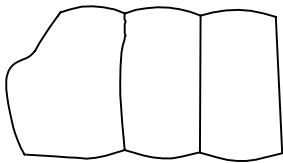

Bx1

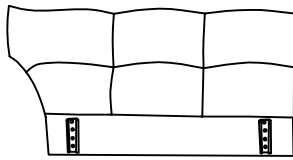

Cx1

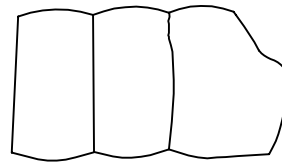

Dx1

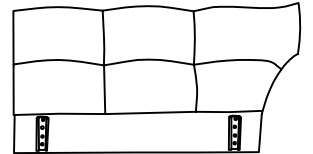

Ex1

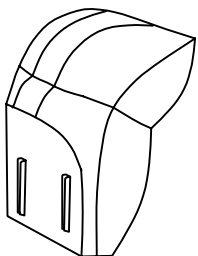

Fx1

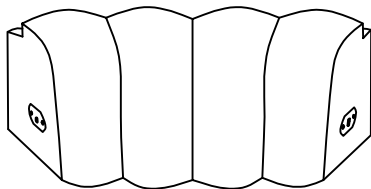

Gx1

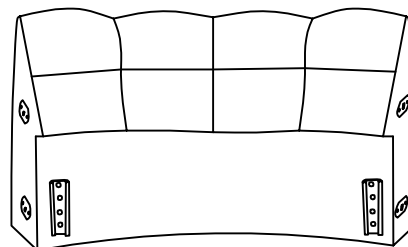

Hx1

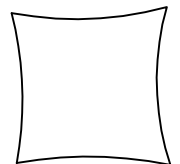

Ix3

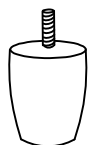

(1)x13



(2)x6

1

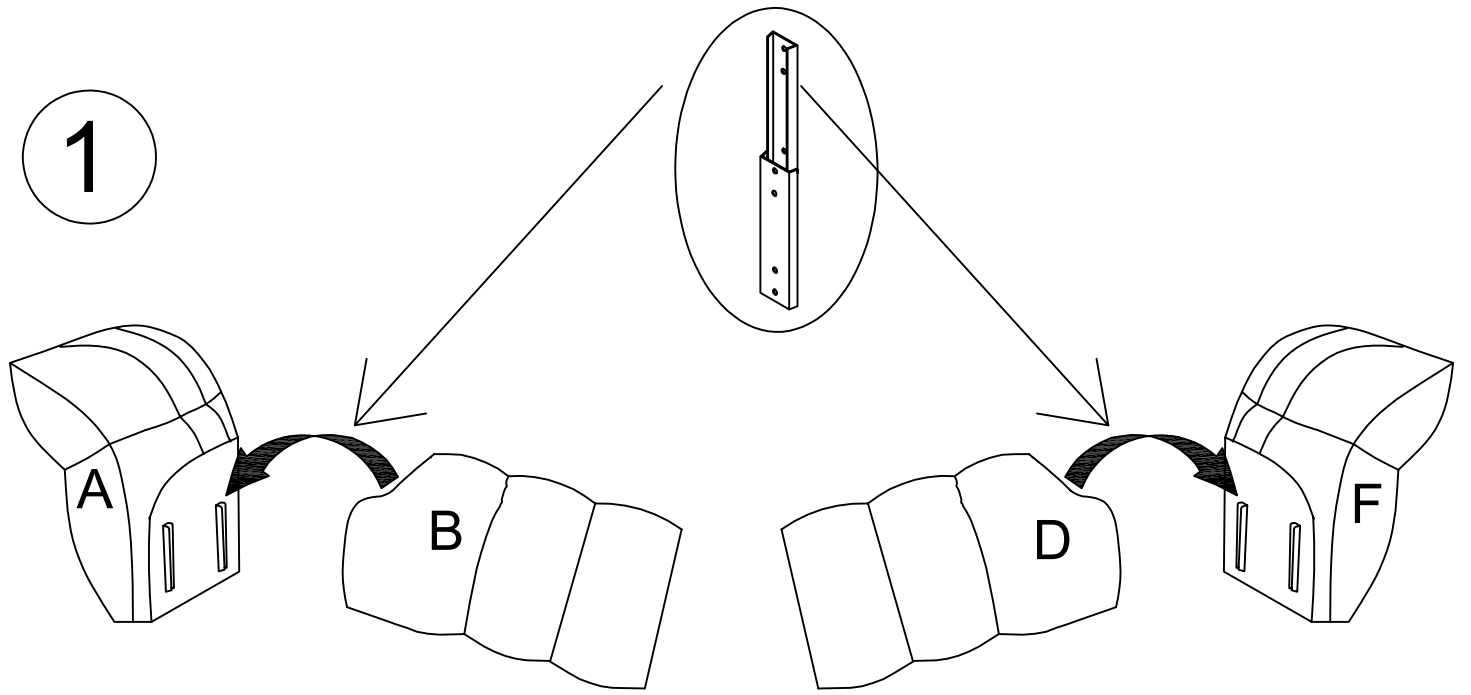

2

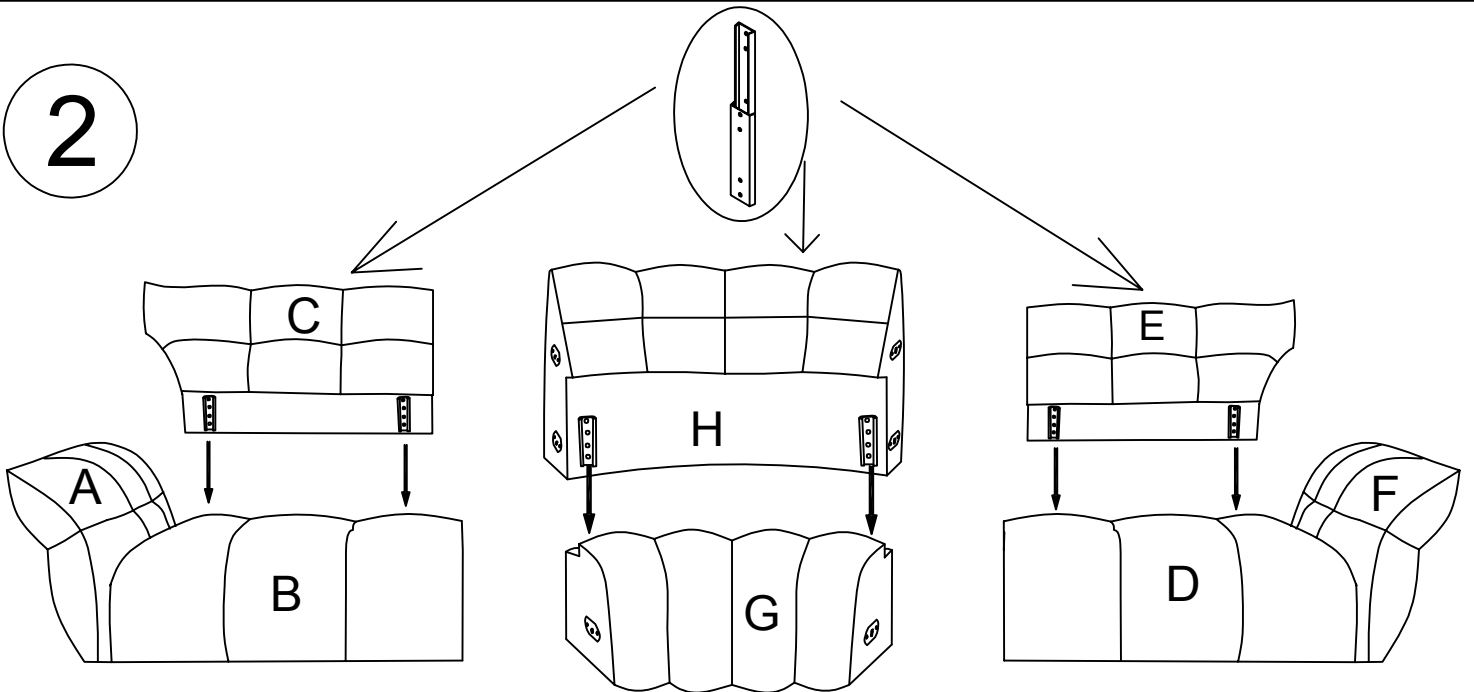

3

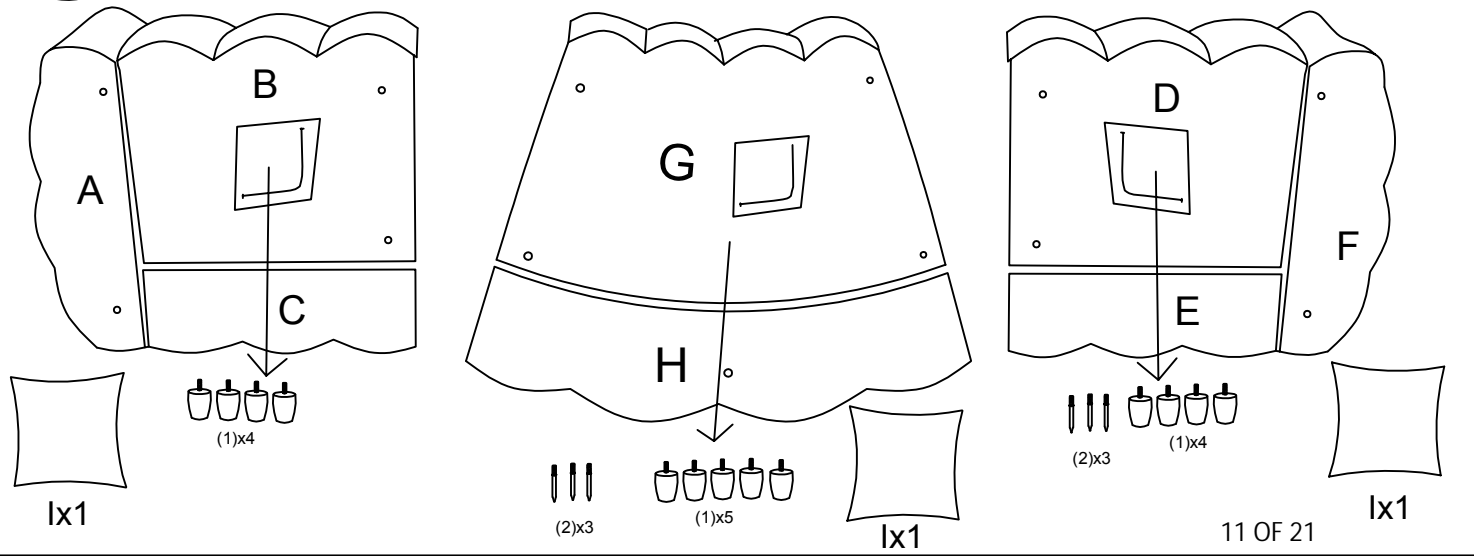

4

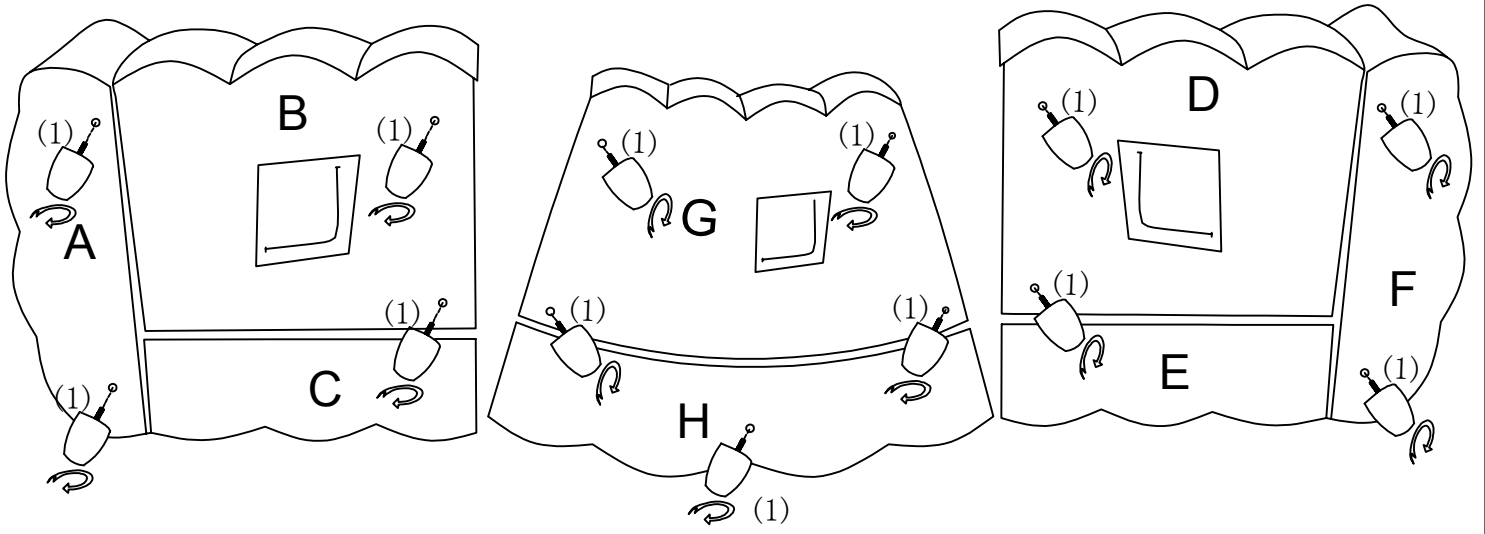

5

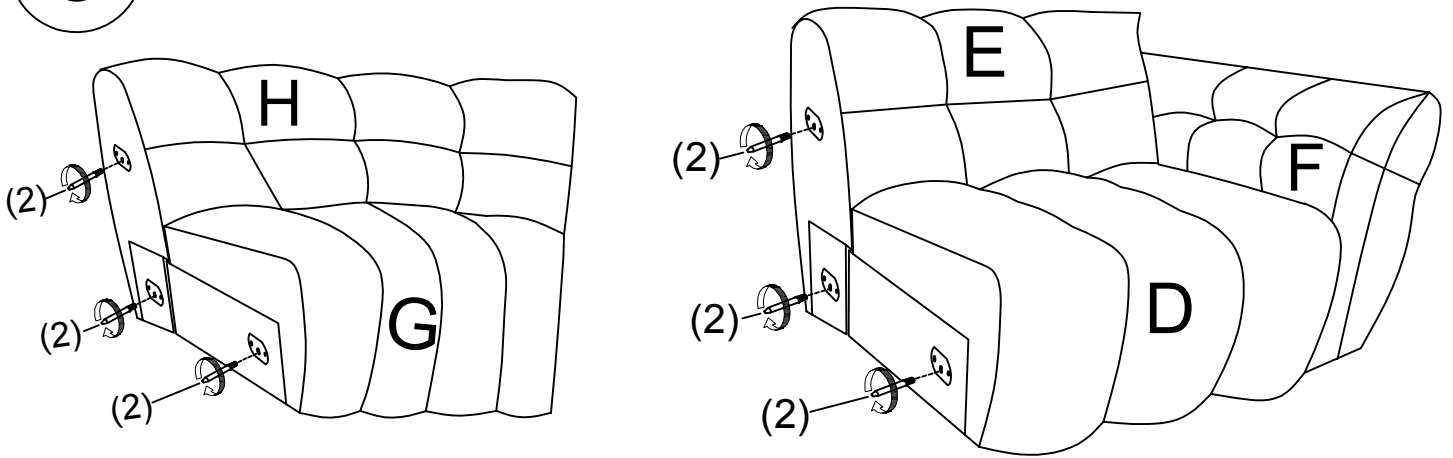

6

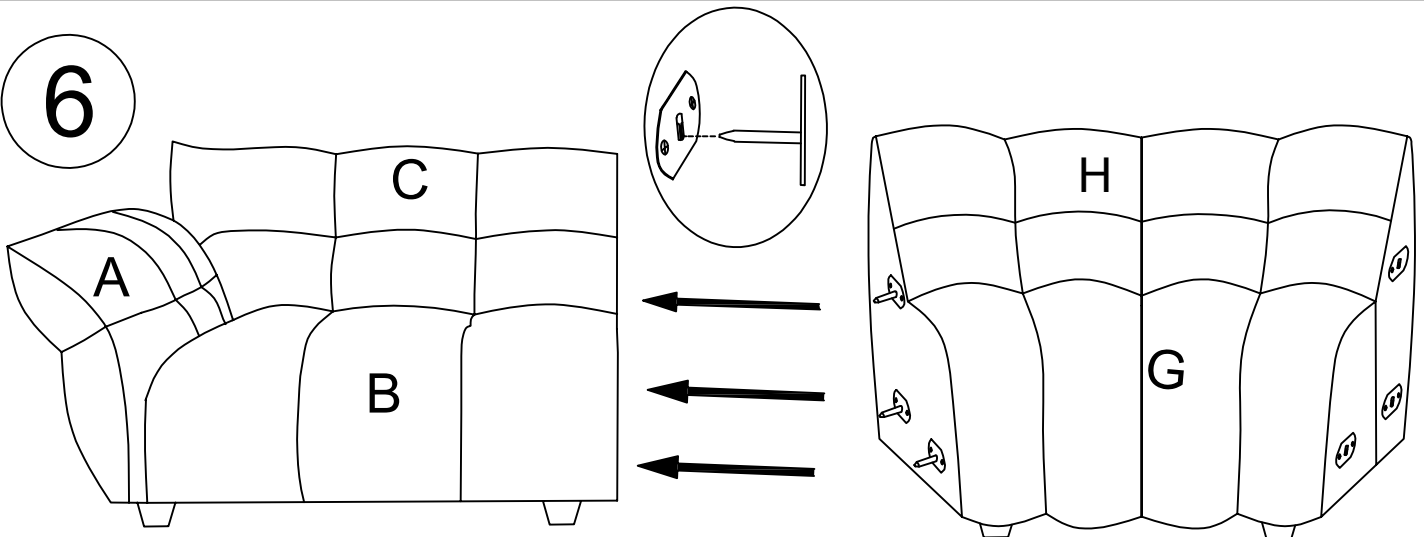

7

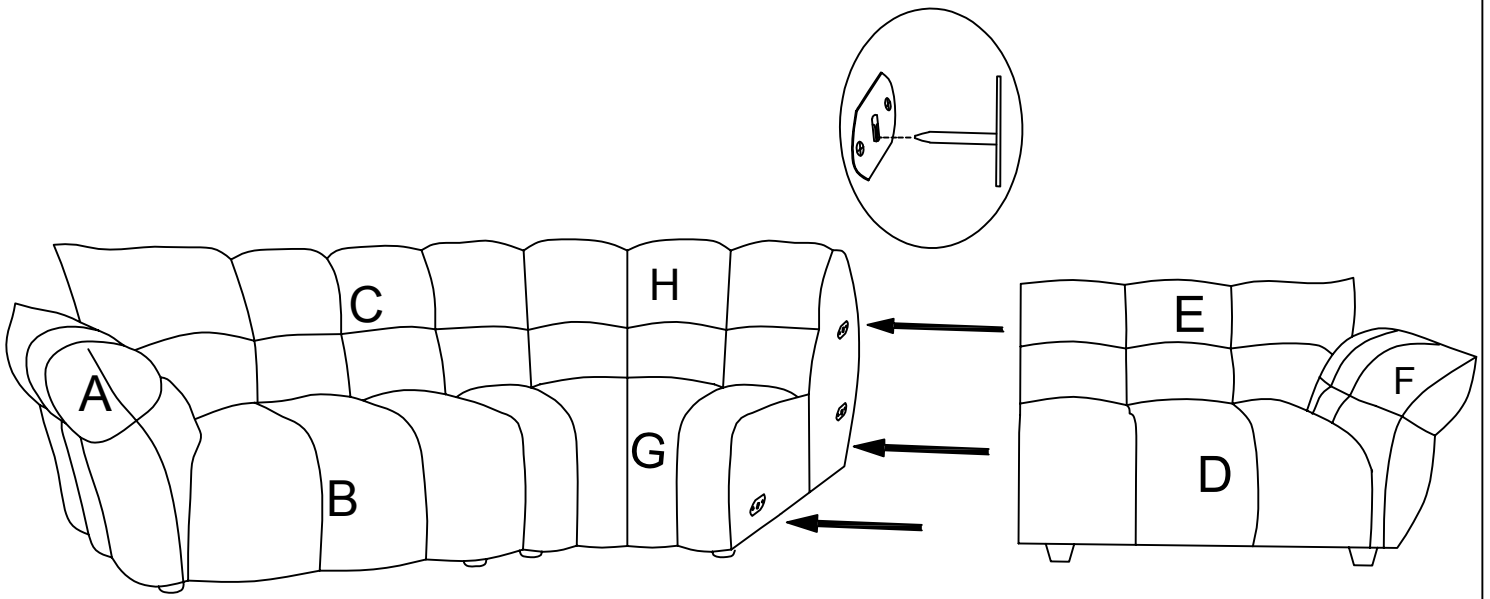

8

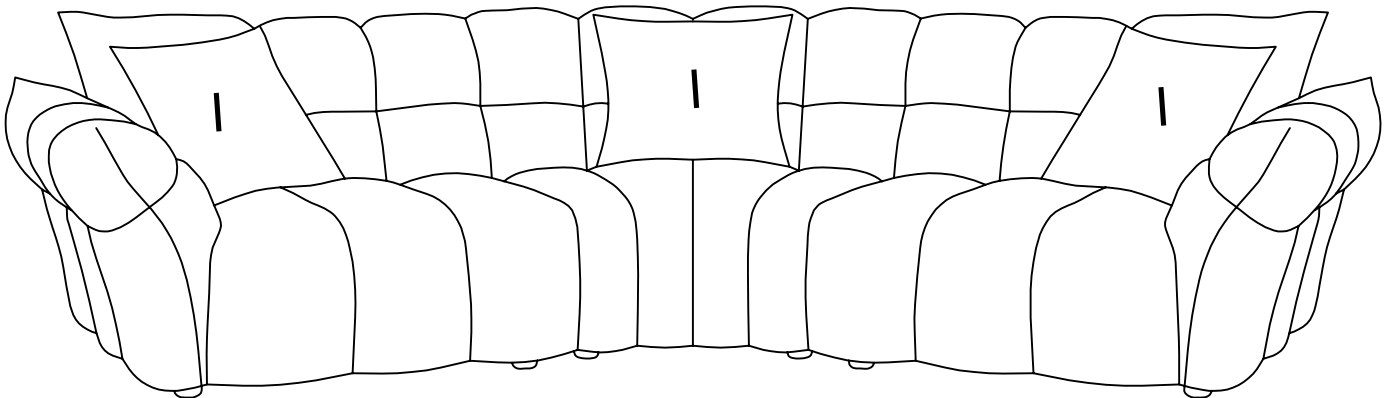

Option 4

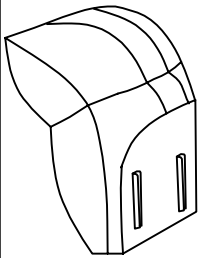
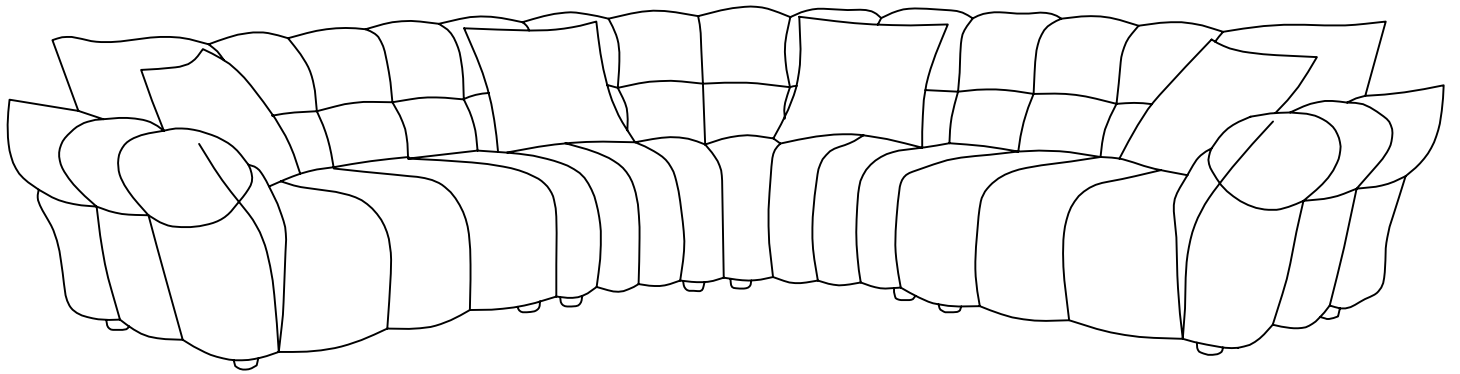
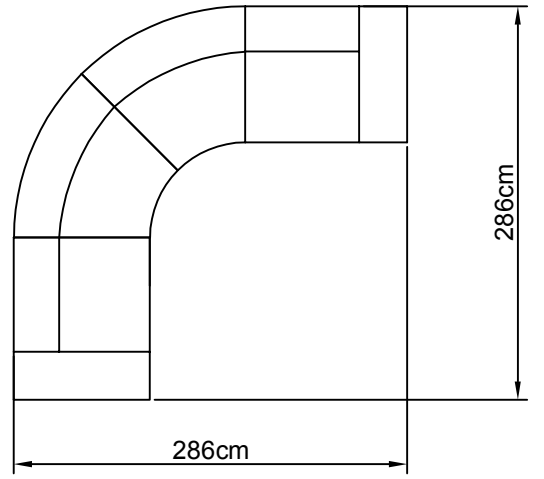

Ax1

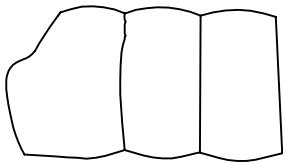

Bx1

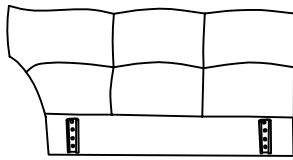

Cx1

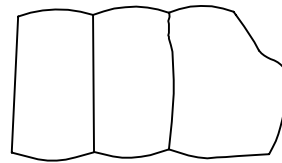

Dx1

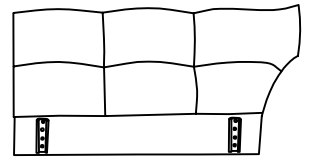

Ex1

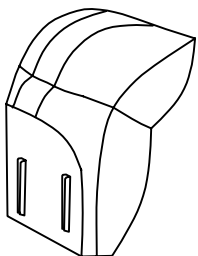

Fx1

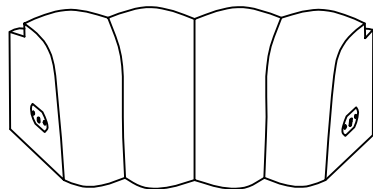

Gx2

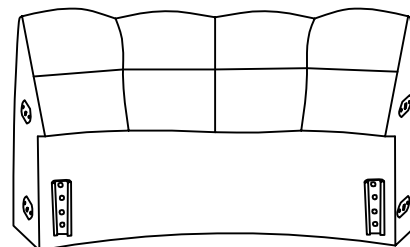

Hx2

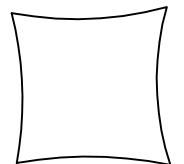

Ix4

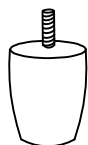

(1)x18



(2)x9

1

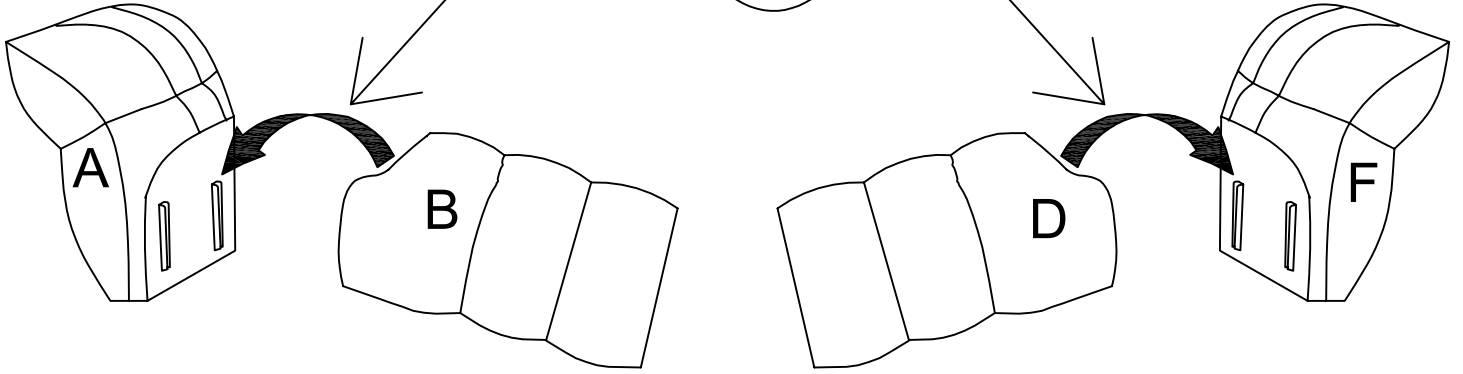
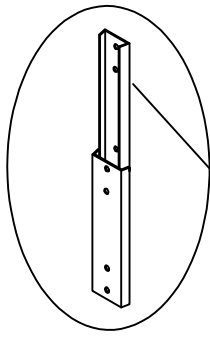

2

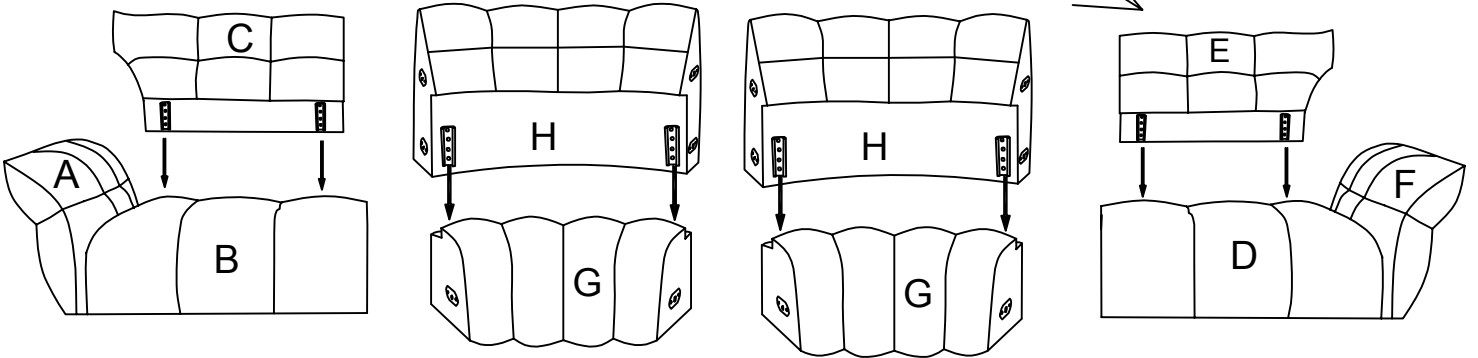
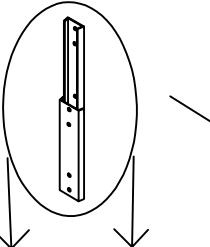

3

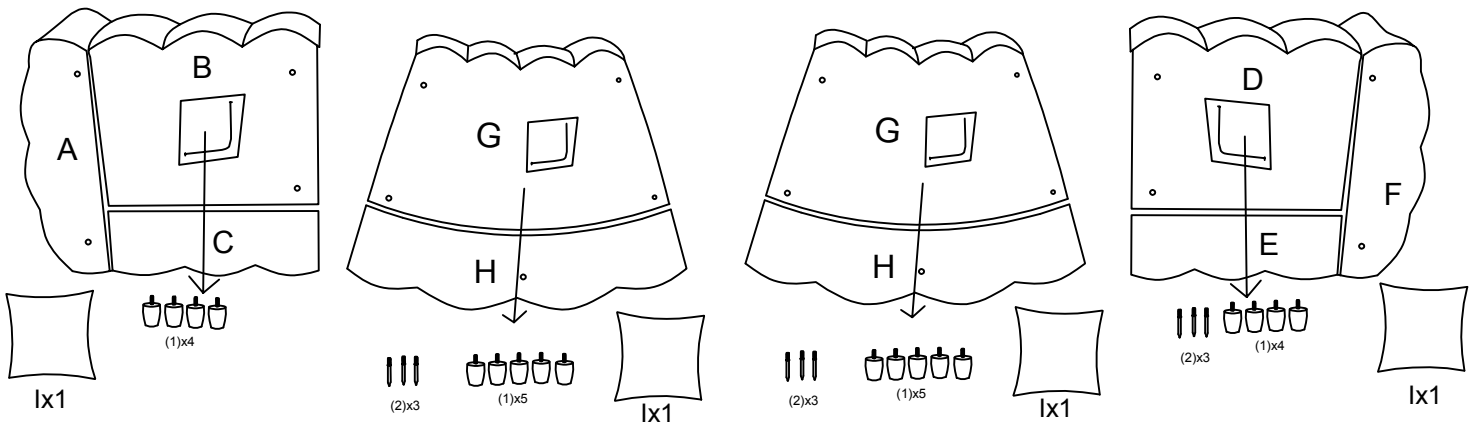

4

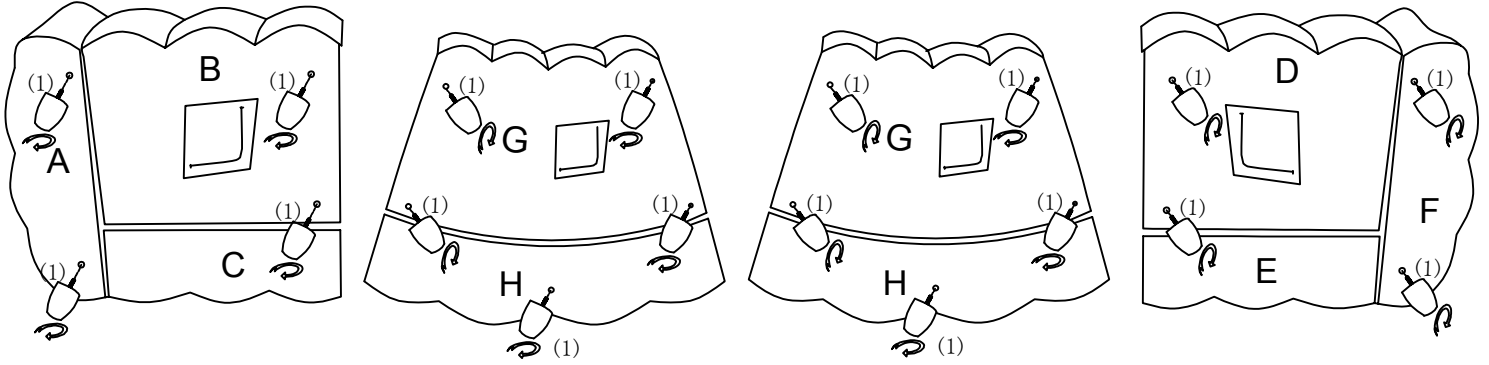

5

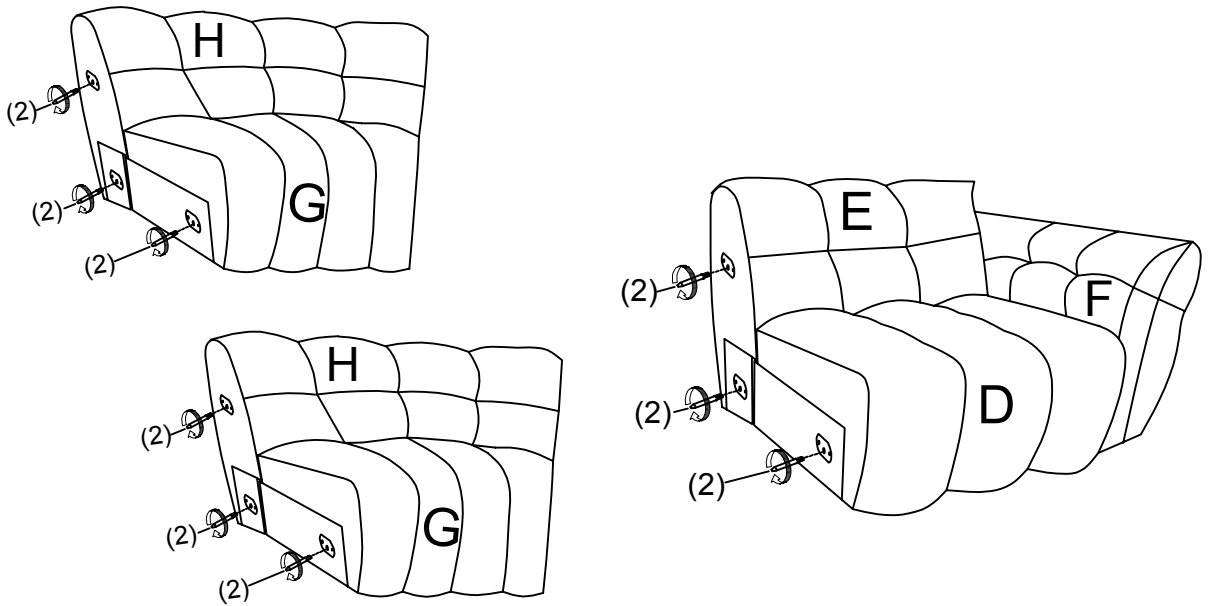

6

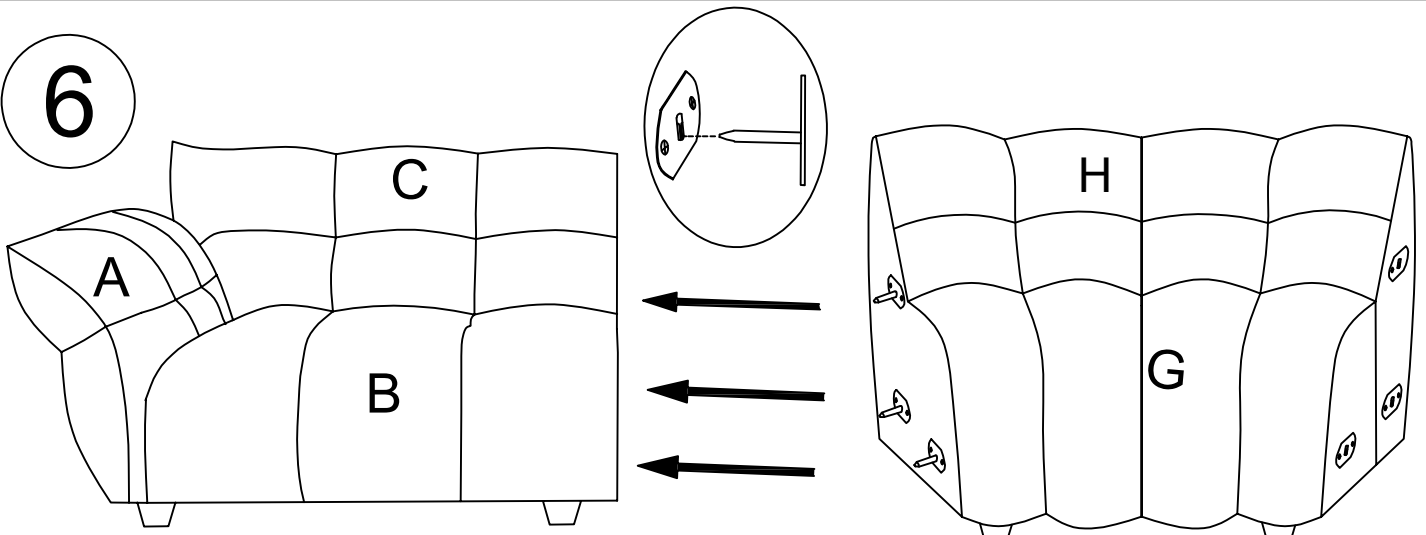

7

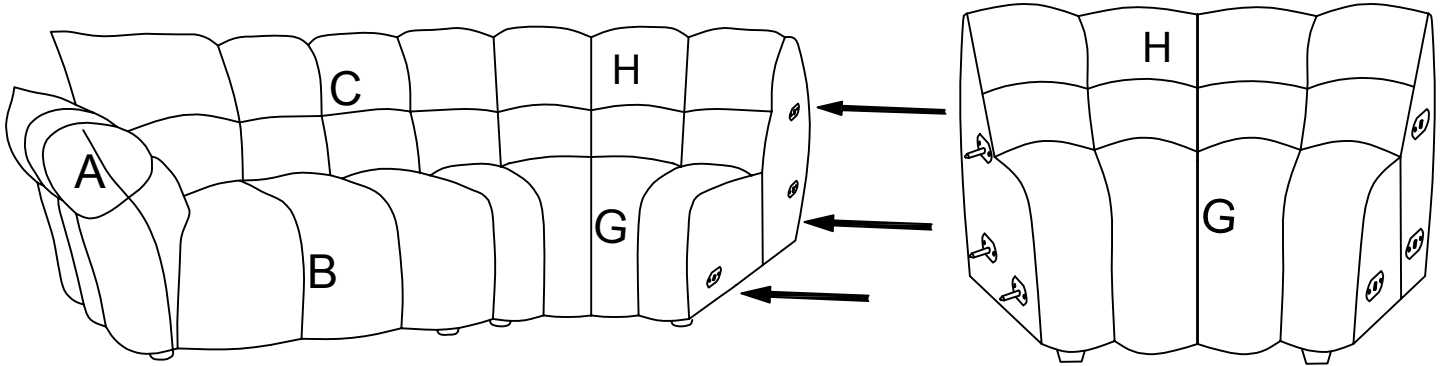
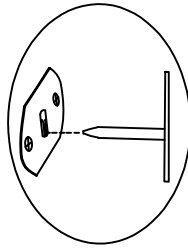

8

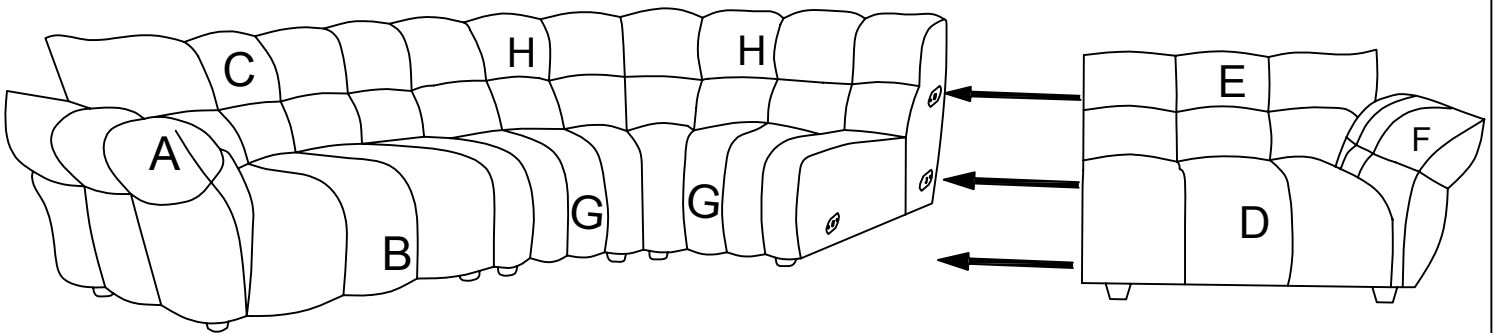

9

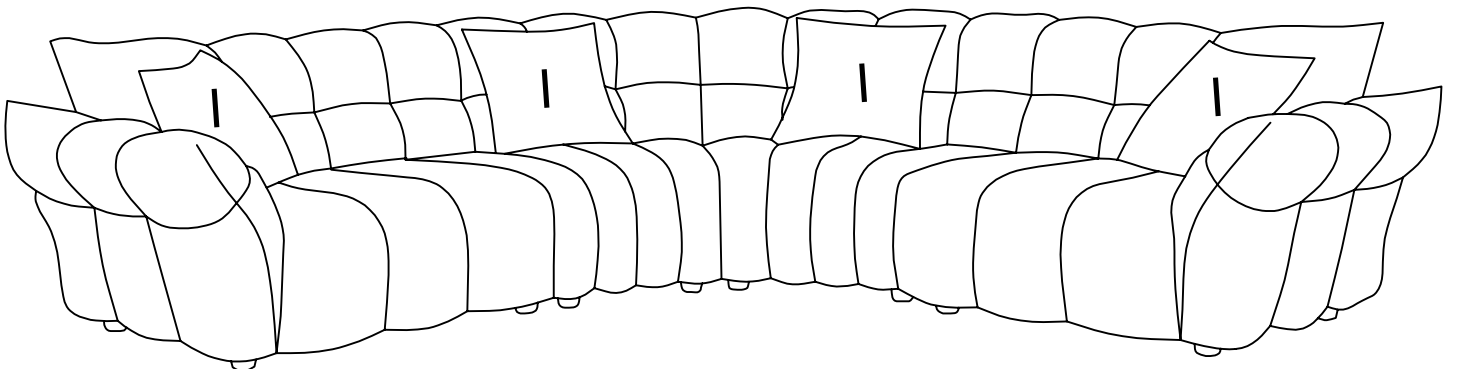

# Option 5

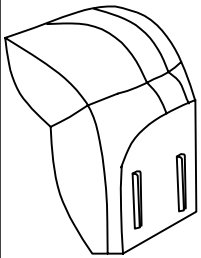
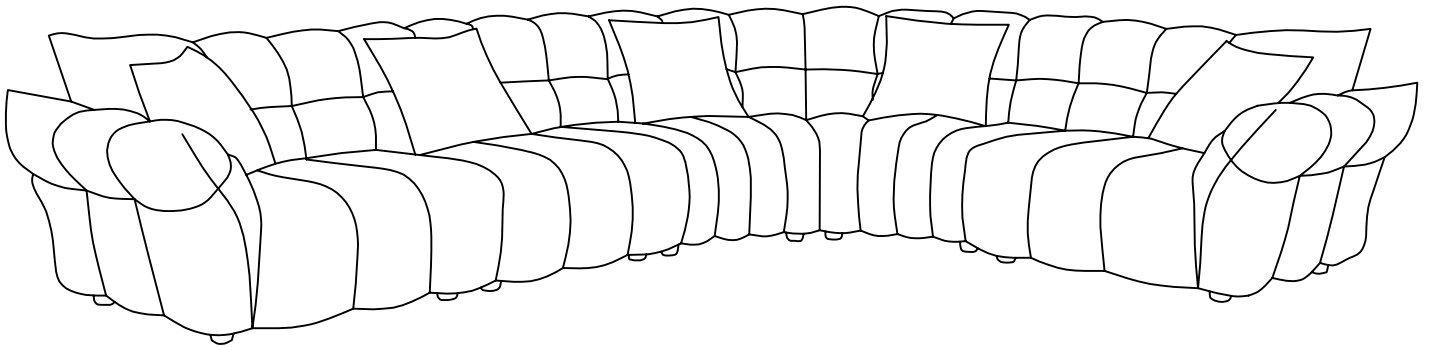
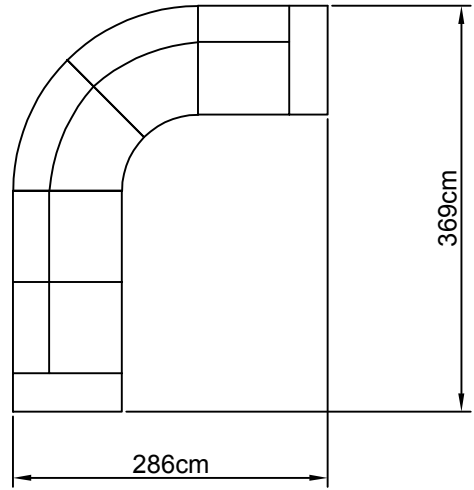

Ax1

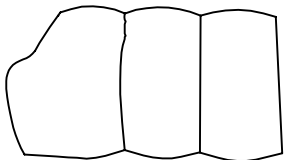

Bx1

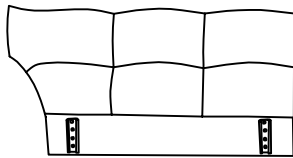

Cx1

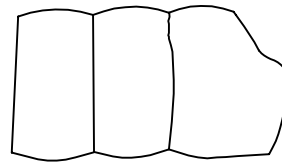

Dx1

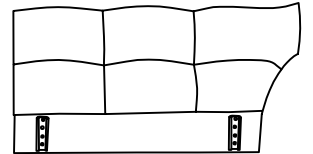

Ex1

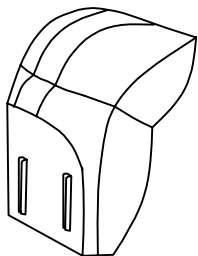

Fx1

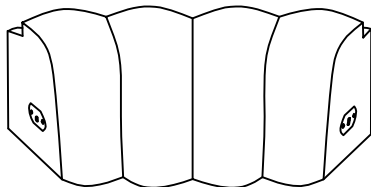

Gx2

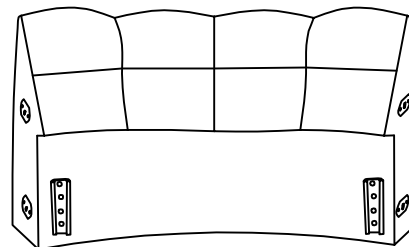

Hx2

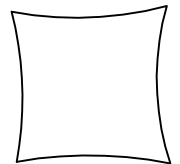

Ix5

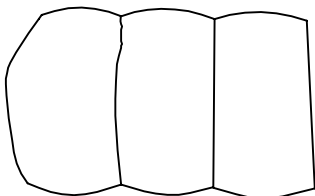

Jx1

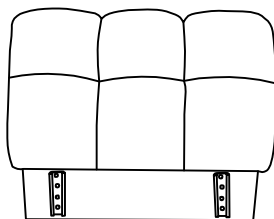

Kx1



(1)x22



(2)x12

1

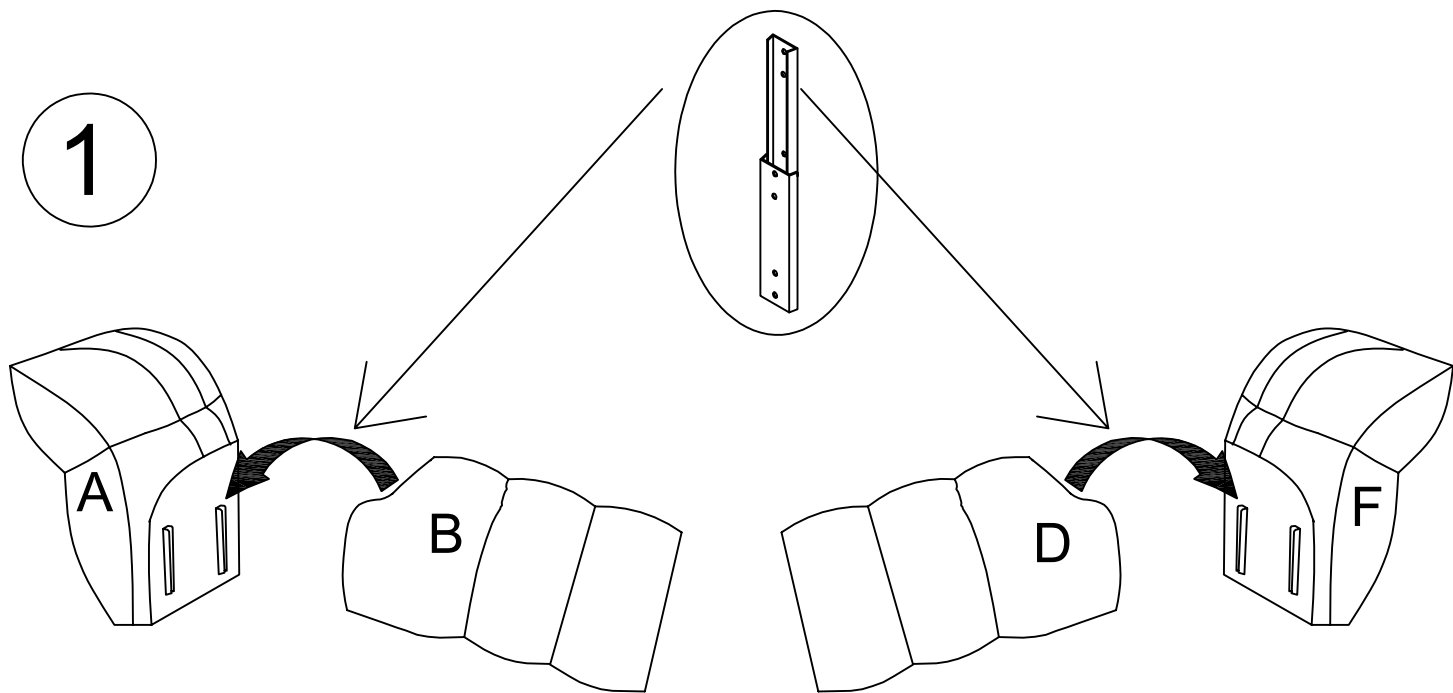

2

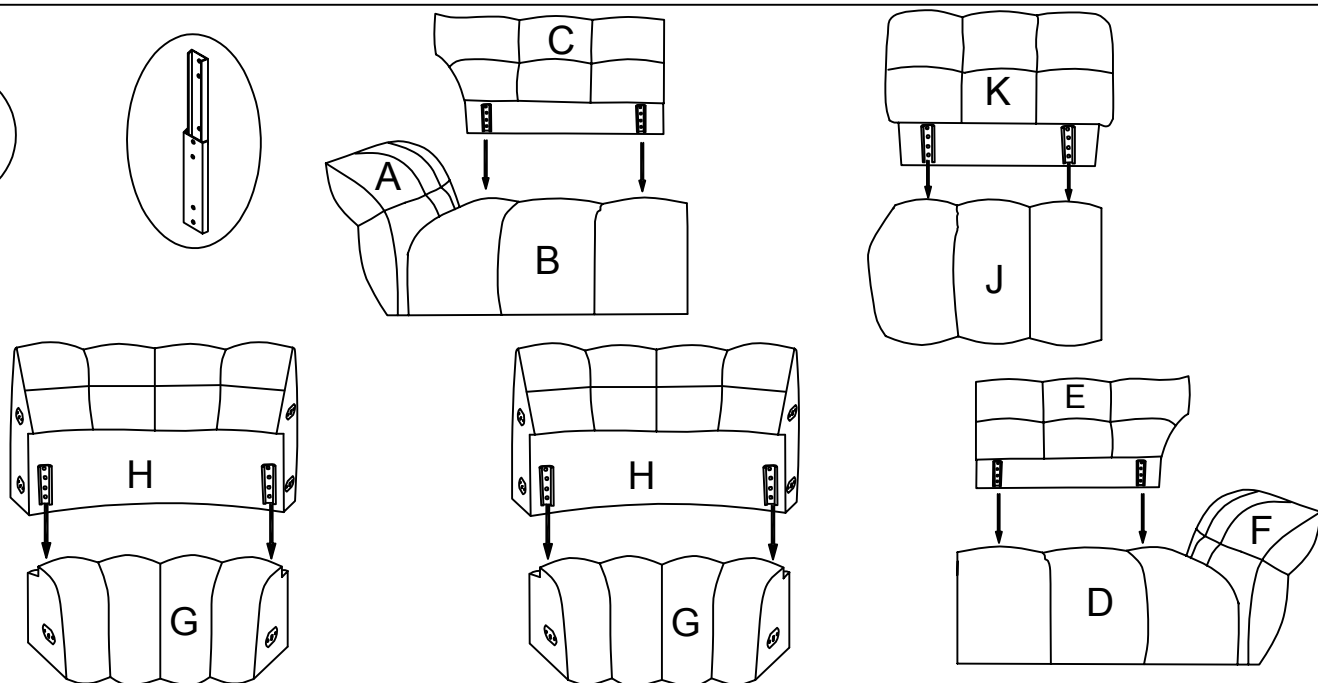

3

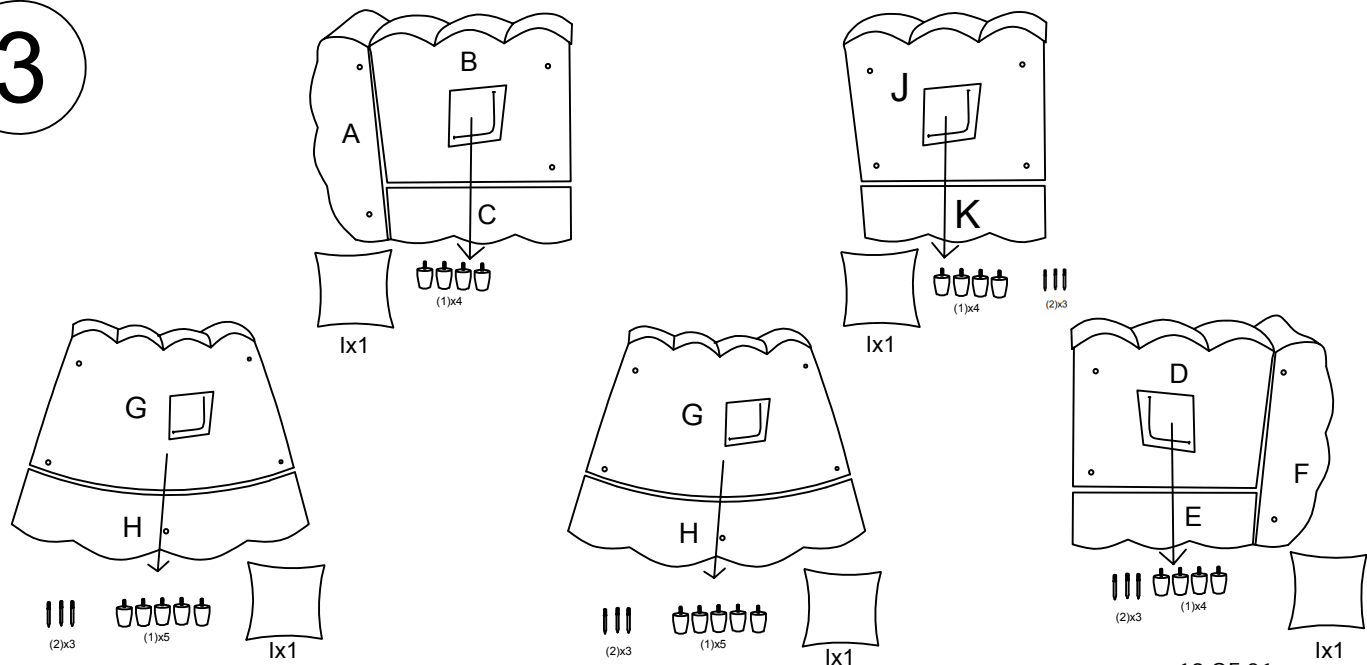

4

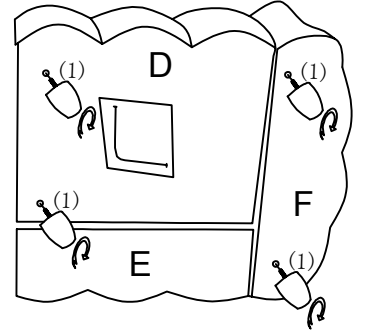
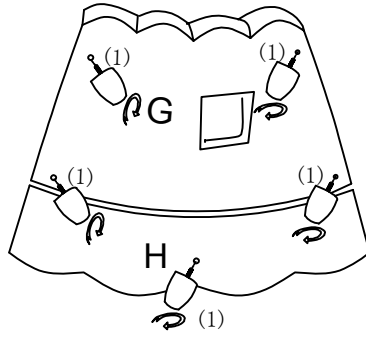
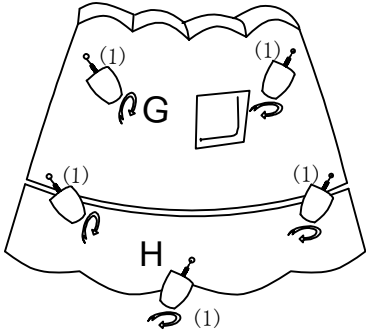
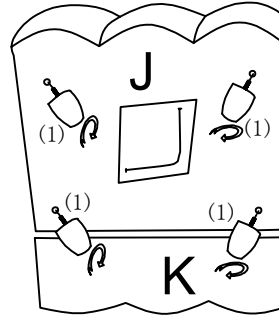
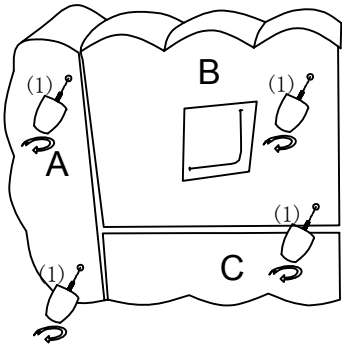

5

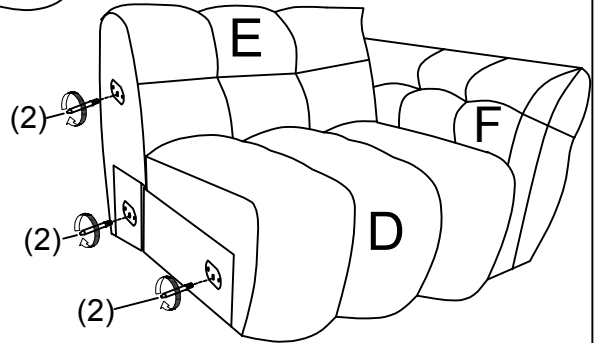
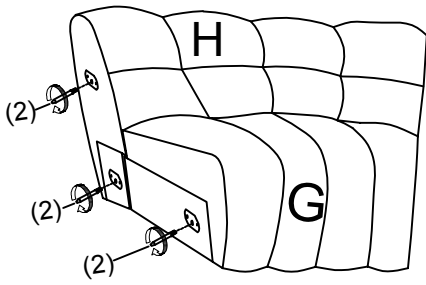
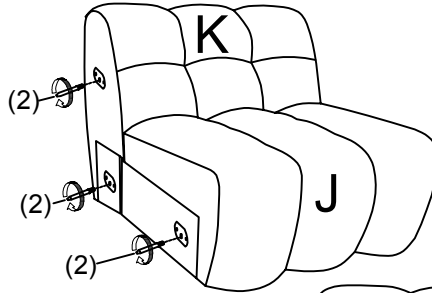
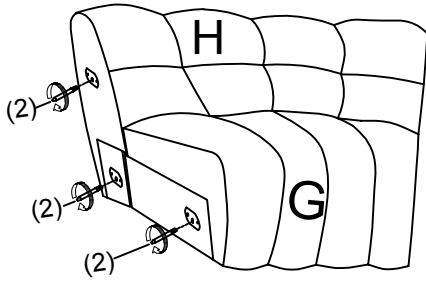

6

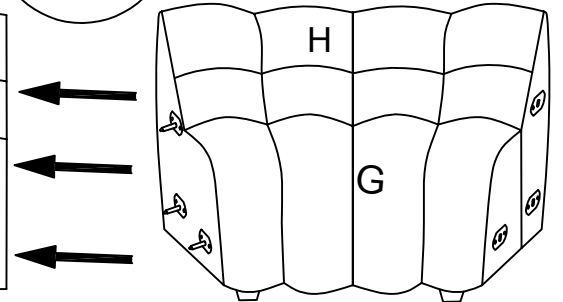
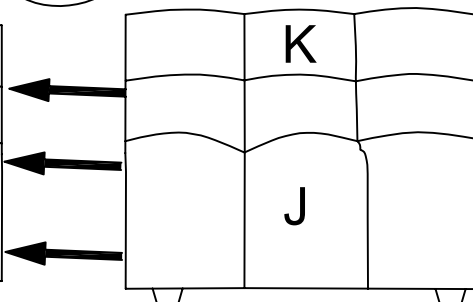
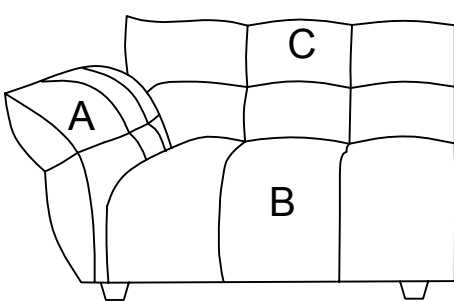
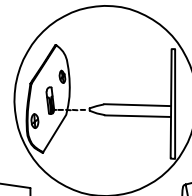
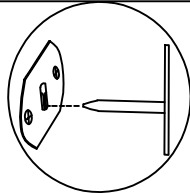

7

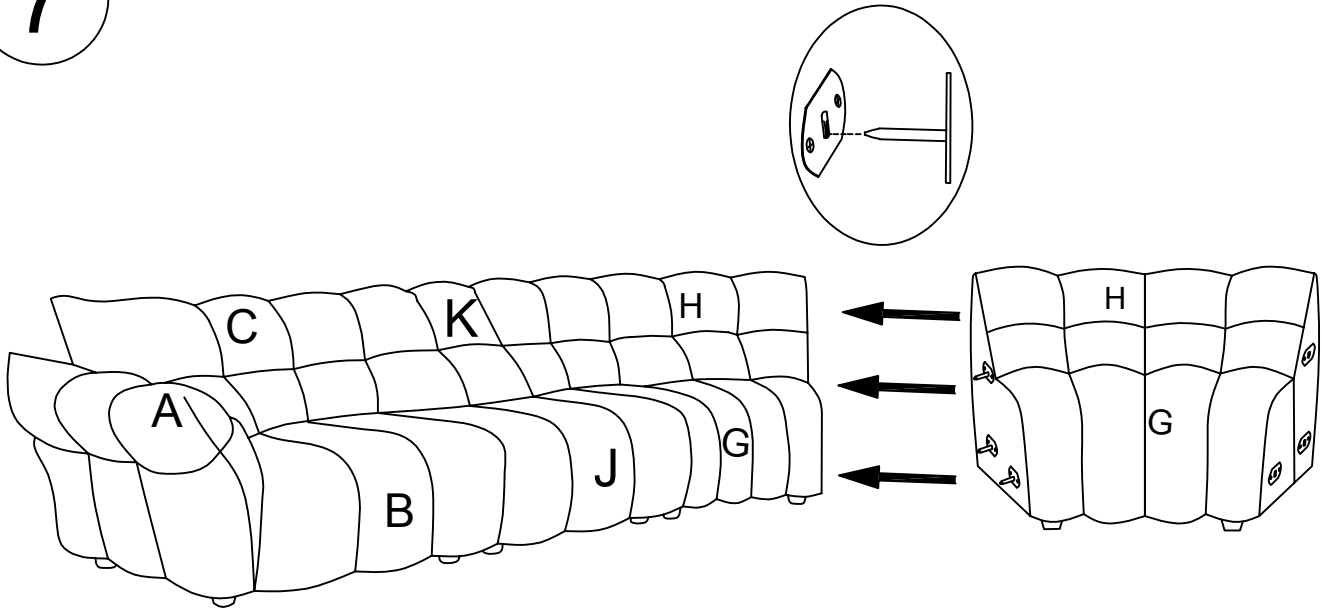

8

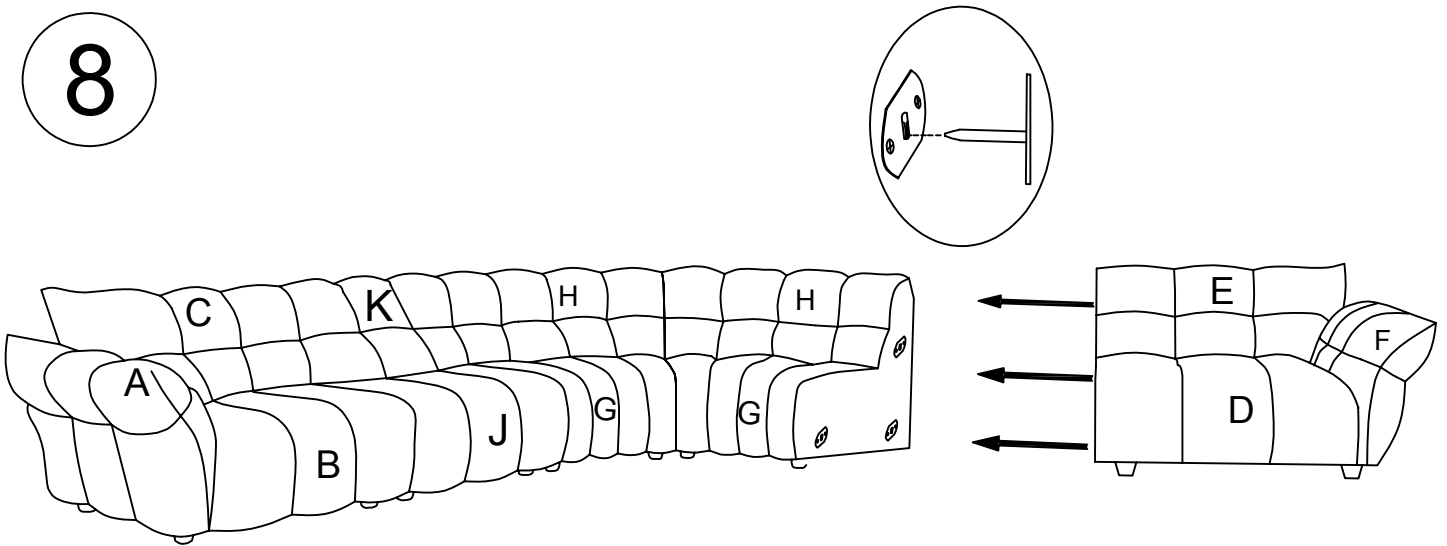

9

